



ICEPLAST
"quality at plastic pipe"

Building Product Catalogue

BİNA ÜRÜN KATALOĞU
КАТАЛОГ ПРОДУКЦИИ ДЛЯ ВНУТРЕННИХ СИСТЕМ
كاتالوج مجموعه البناء



ICE YILDIZ
"plastik boruda kalite"

*Güveniniz
Gücümüz
Oldu...*

Contents / İindekiler

WASTE WATER PIPE AND FITTINGS

PİS SU BORU VE EK PARALARI

PVC-U WASTE WATER PIPE AND FITTINGS (TYPE B-BD) *PVC-U B-BD TİPİ PİS SU BORU VE EK PARALARI*

PVC-U PIPES (TYPE 2) *PVC-U ÖZEL AMALI BORU*

EGE PP TYPE B WASTE WATER PIPE AND FITTINGS *EGE PP B TİPİ PİS SU BORU VE EK PARALARI*

FIRE RESISTANT EGE PP PIPES AND FITTINGS *EGE PP YANMAYA DAYANIKLI BORU VE EK PARALARI*

EGETHERM PP-R TYPE 3 SANITARY PIPES AND FITTINGS

EGETHERM PP-R TYPE 3 BORU VE EK PARALARI

EGE COMPOSITE PIPE *EGE KOMPOZİT BORU*

PVC-U RAIN GUTTER AND DOWN PIPES

PVC-U ATI OLUĐU VE YAĐMUR İNİŐ BORULARI

HEATINGS SYSTEMS PIPES AND FITTINGS

ISITMA SİSTEMLERİ BORU VE EK PARALARI

PVC WASTE WATER PIPE AND FITTINGS

PVC PİS SU
BORU VE EK
PARÇALARI

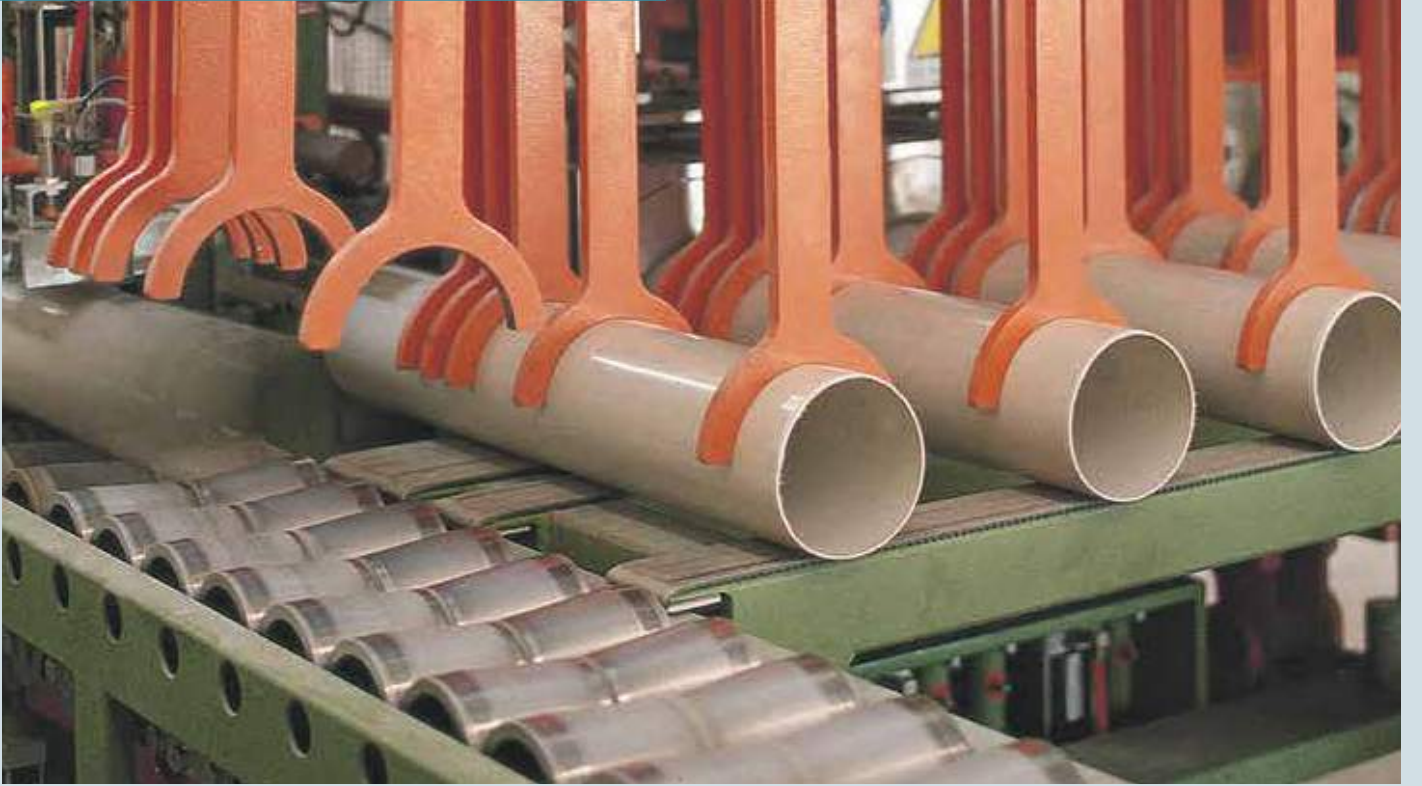

TS EN ISO 9001:2000



PVC-U WASTE WATER PIPE AND FITTINGS

PVC-U Waste Water Pipes and Fittings with sealing ring and stable gasket is manufactured firstly by Egeplast and patented. The production complying with the standard of TS EN 1329-1 are in two types, namely B and BD types.

Application Area

Waste Water Systems for buildings (hot and cold). Ventilation Systems in the waste water systems for buildings. Down Pipes in Rain Gutter Systems. B Type Waste Water Pipes and Fittings are used inside the buildings. BD Type Waste Water Pipes and Fittings are used inside building and outside building installed on the wall or underground within 1 m distance from the buildings. We also manufacture another type of PVC pipes with less wall thickness named "Type 2", which was included in the old standard.

PVC-U PİS SU BORU VE EK PARÇALARI

PVC-U Pis Su Boru ve Ek Parçaları, segmanlı, sabit contalı olarak Türkiye'de ilk defa Egeplast tarafından üretilmiştir. Üretim B ve BD olmak üzere 2 tipte olup, TS 275-1 EN 1329-1 standardı kapsamında yapılmaktadır.

Kullanım Sahası

Evsel atık sular (sıcak-soğuk)
Evsel atık su hatları için havalandırma sistemleri
Bina yağmur suyu tesisatlarında kullanılır.

B Tipi Pis Su Boru ve Ek Parçaları sadece bina içlerinde, BD Tipi Pis Su Boru ve Ek Parçaları ise bina içlerinde ve bina içi toprak altına gömülü olarak kullanılır. Bu standart üretimimiz dışında daha ince et kalınlığında Özel Amaçlı adı altında PVC boru üretimimiz de mevcuttur.

COMPARISON OF THE WALL THICKNESSES OF DIFFERENT TYPES STANDART KAPSAMINDAKİ PVC-U PİS SU BORU VE EK PARÇALARI İLE PVC-U ÖZEL AMAÇLI PİS SU BORU VE EK PARÇALAR

Diameter Ød mm Çap Ød mm	TS 275-1 EN		TYPE 2 S min. Özel Amaçlı S min.
	TYPE B S min. B Tipi S min.	TYPE BD S min. BD Tipi S min.	
Ød 50	3,0 mm	-	1,8
Ød 75	3,0 mm	3,0 mm	1,8
Ød 110	3,2 mm	3,2 mm	2,2
Ød 125	3,2 mm	3,2 mm	2,5
Ød 160	3,2 mm	4,0 mm	-
Ød 200	3,9 mm	4,9 mm	-
Ød 250	4,9 mm	6,2 mm	-
RING COLOR Ring Rengi	BLUE Mavi	BLUE Mavi ORANGE Turuncu	YELLOW Sarı

PVC-U WASTE WATER PIPE AND FITTINGS

PVC-U WASTE WATER PIPES
PVC-U PİS SU BORULARI

ПВХ труба для сточных вод

أنبوب بي في سي

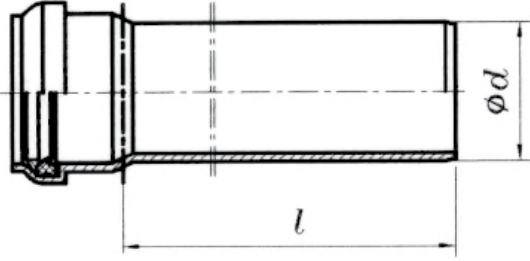

Building Group / Bina Grubu

ITEM CODE	Nominal Diameter	Outside Diameter	Type	Length (mm)	Pcs/Pkg
Kod No	Anma Çapı	Dış Çap Ød (mm)	Tip	Boy (mm)	Adet/Paket
055010500150	50	50	B	150	100
055010500250	50	50	B	250	75
055010500500	50	50	B	500	40
055010501000	50	50	B	1000	10
055010502000	50	50	B	2000	10
055010503000	50	50	B	3000	10
055010506000	50	50	B	6000	1
055010700150	70	75	BD	150	60
055010700250	70	75	BD	250	35
055010700500	70	75	BD	500	10
055010700750	70	75	BD	750	20
055010701000	70	75	BD	1000	10
055010702000	70	75	BD	2000	1
055010703000	70	75	BD	3000	1
055010706000	70	75	BD	6000	1
055011000150	100	110	BD	150	25
055011000250	100	110	BD	250	20
055011000500	100	110	BD	500	10
055011000750	100	110	BD	750	10
055011001000	100	110	BD	1000	10
055011002000	100	110	BD	2000	1
055011003000	100	110	BD	3000	1
055011006000	100	110	BD	6000	1
055011250150	125	125	BD	150	20
055011250250	125	125	BD	250	13
055011250500	125	125	BD	500	7
055011250750	125	125	BD	750	7
055011251000	125	125	BD	1000	7
055011252000	125	125	BD	2000	1
055011253000	125	125	BD	3000	1
055011256000	125	125	BD	6000	1
050011500150	150	160	B	150	9
050011500250	150	160	B	250	9
050011500500	150	160	B	500	4
0500115001000	150	160	B	1000	4
0500115002000	150	160	B	2000	1
0500115003000	150	160	B	3000	1

ITEM CODE	Nominal Diameter	Outside Diameter	Type	Length (mm)	Pcs/Pkg
Kod No	Anma Çapı	Dış Çap Ød (mm)	Tip	Boy (mm)	Adet/Paket
0500115006000	150	160	B	6000	1
055011500150	150	160	BD	150	15
055011500250	150	160	BD	250	10
055011500500	150	160	BD	500	4
055011501000	150	160	BD	1000	4
055011502000	150	160	BD	2000	1
055011503000	150	160	BD	3000	1
055011506000	150	160	BD	6000	1
050012000150	200	200	B	150	6
050012000250	200	200	B	250	6
050012000500	200	200	B	500	3
050012001000	200	200	B	1000	3
050012002000	200	200	B	1000	1
050012003000	200	200	B	3000	1
050012006000	200	200	B	6000	1
055012000150	200	200	BD	150	9
055012000250	200	200	BD	250	9
055012000500	200	200	BD	500	4
055012001000	200	200	BD	1000	4
055012002000	200	200	BD	2000	1
055012003000	200	200	BD	3000	1
055012006000	200	200	BD	6000	1
040012500150	250	250	B	150	1
040012500250	250	250	B	250	1
040012500500	250	250	B	500	1
040012501000	250	250	B	1000	1
040012502000	250	250	B	2000	1
040012503000	250	250	B	3000	1
040012506000	250	250	B	6000	1
045012500150	250	250	BD	150	1
045012500250	250	250	BD	250	1
045012500500	250	250	BD	500	1
045012501000	250	250	BD	1000	1
045012502000	250	250	BD	2000	1
045012503000	250	250	BD	3000	1
045012506000	250	250	BD	6000	1

PVC-U WASTE WATER PIPE AND FITTINGS

ITEM CODE Kod No	Ød Ød	Type Tip	l1(mm) l1(mm)	l2(mm) l2(mm)	Pcs/pkg Adet/paket
05537050	50	B	51	20	200
05537070	75	BD	64	28	80
05537100	110	BD	86	30	30
05537125	125	BD	101	33	20
05037150	160	B	115	45	10
05537150	160	BD	115	45	10
05037200	200	B	143	54	5

ELBOW 45°
AÇIK DİRSEK 45°
ПВХ угольник 45°
45° كوع

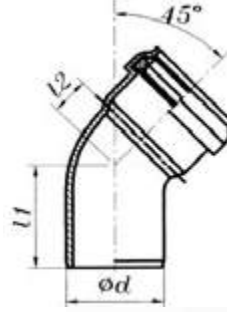

ITEM CODE Kod No	Ød Ød	Type Tip	l1(mm) l1(mm)	l2(mm) l2(mm)	Pcs/pkg Adet/paket
05538050	50	B	70	28	175
05538070	75	BD	83	43	60
05538100	110	BD	121	70	20
05538125	125	BD	135	78	15
05038150	160	B	165	93	8
05538150	160	BD	165	93	8
05038200	200	B	205	110	5

ELBOW 87,5°
KAPALI DİRSEK 87,5°
ПВХ угольник 87,5°
87,5° كوع

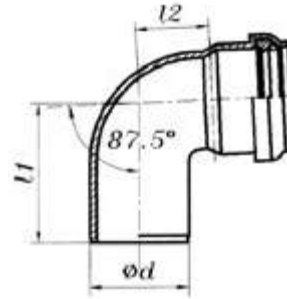

ITEM CODE Kod No	Ød1 Ød1	Ød2 Ød2	Type Tip	l1(mm) l1(mm)	l2(mm) l2(mm)	Pcs/pkg Adet/paket
055300500050	50	50	B	114	61	80
055300700050	75	50	BD	123	78	50
055300700070	75	75	BD	156	92	30
055301000050	110	50	BD	136	106	25
055301000070	110	75	BD	168	114	20
055301000100	110	110	BD	220	139	10
055301250050	125	50	BD			10
055301250070	125	75	BD	175	130	15
055301250100	125	110	BD	225	143	10
055301250125	125	125	BD	247	150	8
050301500070	160	75	B			5
050301500100	160	110	B	237	168	6
050301500125	160	125	B	330	260	4
050301500150	160	160	B	308	193	4
055301500100	160	110	BD	255	200	6
055301500125	160	125	BD	330	260	4
055301500150	160	160	BD	330	215	4
055302000100	200	110	BD	330	235	3
055302000125	200	125	BD	330	270	3
055302000150	200	160	BD	330	220	3
055302000200	200	200	B	435	320	2

SINGLE BRANCH 45°
TEK ÇATAL 45°
ПВХ тройник 45°
45° وصله

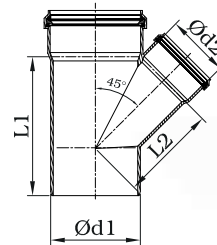

PVC-U WASTE WATER PIPE AND FITTINGS

TEE BRANCH 87,5°
TE ÇATAL 87,5°
ПВХ тройник 87,5°
87,5° تي

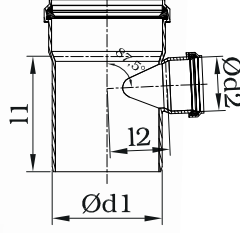

ITEM CODE Kod No	Ød1 Ød1	Ød2 Ød2	Type Tip	l1(mm) l1(mm)	l2(mm) l2(mm)	Pcs/pkg Adet/paket
055290500050	50	50	B	94	27	90
055290700050	75	50	BD	115	40	50
055290700070	75	75	BD	132	45	30
055291000050	110	50	BD	118	54	30
055291000070	110	75	BD	145	59	20
055291000100	110	110	BD	179	62	15
055291250070	125	75	BD	200	135	10
055291250100	125	110	BD	197	72	15
055291250125	125	125	BD	198	72	10
050291500100	160	110	B	253	170	5
050291500125	160	125	B	253	155	5
050291500150	160	160	B	253	90	5
055291500100	160	110	BD	253	170	5
055291500125	160	125	BD	253	155	5
055291500150	160	160	BD	253	90	5
050292000100	200	110	B	305	170	5
050292000125	200	125	B	310	150	5
050292000150	200	160	B	310	130	5
050292000200	200	200	B	363	130	3

DOUBLE BRANCH 45°
ÇİFT ÇATAL 45°
ПВХ крестовина 45°
وصله تجميع مزدوج 45°

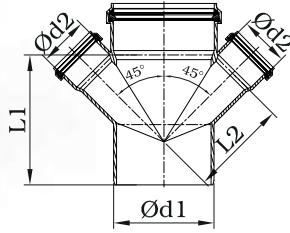

ITEM CODE Kod No	Ød1 Ød1	Ød2 Ød2	Type Tip	l1(mm) l1(mm)	l2(mm) l2(mm)	Pcs/pkg Adet/paket
055280500050	50	50	B	115	61	80
055280700050	75	50	BD	127	78	50
055280700070	75	75	BD	162	92	30
055281000050	110	50	BD	150	103	20
055281000070	110	75	BD			10
055281000100	110	110	BD	217	133	8
055281250070	125	75	BD	225	184	8
055281250100	125	110	BD	225	144	7
055281250125	125	125	BD	314	198	4

CLEANOUT TEE
TEMİZLEME TE
ПВХ ревизия
تي مع فتحة تنظيف

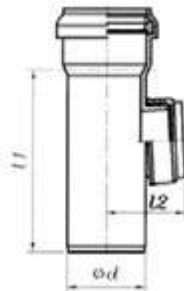

ITEM CODE Kod No	Ød Ød	Type Tip	l1(mm) l1(mm)	l2(mm) l2(mm)	Pcs/pkg Adet/paket
05544050	50	B	103	48	75
05544070	75	BD	130	68	40
05544100	110	BD	178	78	15
05544125	125	BD	215	88	10
05044150	160	B	250	124	5
05544150	160	BD	250	124	5
05044200	200	B	310	125	3

PVC-U WASTE WATER PIPE AND FITTINGS

ITEM CODE	d1	d2	d3	Type	Pcs/pkg
Kod No	d1	d2	d3	Tip	Adet/paket
056310500050	50	50	50	B	50
056310700050	75	50	50	BD	25
056310700070	75	70	75	BD	25
056311000050	110	50	50	BD	15
056301000100	110	110	110	BD	

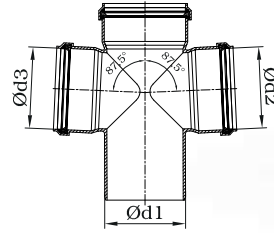

DOUBLE BRANCH
İSTAVROZ
КРЕСТОВИНА
مجمع



ITEM CODE	Ød	Type	l1(mm)	Pcs/pkg
Kod No	Ød	Tip	l1(mm)	Adet/Paket
05517050	50	B	100	175
05517070	75	BD	115	75
05517100	110	BD	145	35
05517125 E	125	BD	152	25
05017150 E	160	B	200	10
05017200	200	B	250	5

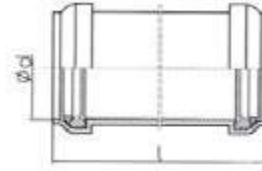

COLLAR SLEEVE
KAYAR MANŞON
ПВХ муфта
وصله



ITEM CODE	Ød1	Ød2	Type	l1(mm)	Pcs/pkg
Kod No	Ød1	Ød2	Tip	l1(mm)	Adet/paket
055190700050	75	50	BD	69	100
055191000050	110	50	BD	101	50
055191000070	110	75	BD	88	40
055191250070	125	75	BD	170	25
055191250100	125	110	BD	84	25
055191500070	160	75	B	185	20
050191500100	160	110	B	125	20
050191500125	160	125	B	107	15
055191500100	160	110	BD	116	20
055191500125	160	125	BD	107	15
050192000100 E	200	110	B	149	15
050192000125	200	125	B	265	10
050192000150 E	200	160	B	129	10

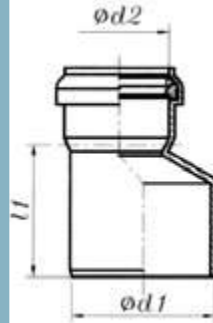

REDUCER
REDÜKSİYON
ПВХ переходник
نقاص



ITEM CODE	Ød	Type	l1(mm)	l2(mm)	Pcs/pkg
Kod No	Ød	Tip	l1(mm)	l2(mm)	Adet/paket
04043100	110	BD	136	342	7

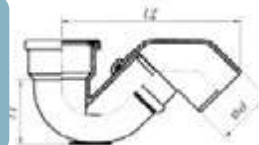

"S" SYPHON
"S" SIFON
ПВХ S сифон
سیفون (S)



PVC-U WASTE WATER PIPE AND FITTINGS

LAVABO SIFON

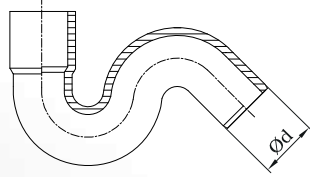

ITEM CODE Kod No	Ød Ød	Pcs/pkg Adet/paket
04739070B	75	150
04739100B	110	130

ENDPLUG
KÖRTAPA

ПВХ заглушка
سد

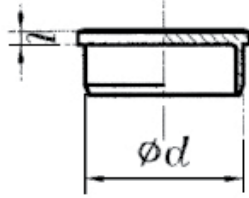

ITEM CODE Kod No	Ød Ød	l1(mm) l1(mm)	Pcs/pkg Adet/Paket
04014050	50	3	500
040140700001	75	3	500
04014100	110	4	150
04014125	125	4,5	100
04014150	160	20	50
04014200	200	20	15

EGE BRACELETTE

EGE KELEPÇE
ПВХ крепление (EGE)
مربط

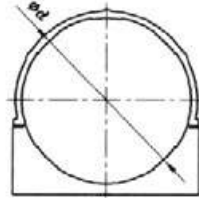

ITEM CODE Kod No	Ød Ød	Pcs/pkg Adet/paket
047390400050 BZ	40	100
047390400050 BZ	50	100
04739070B	75	150
04739100B	110	130

BRACELETTE
PİS SU KELEPÇESİ

ПВХ крепление
مربط

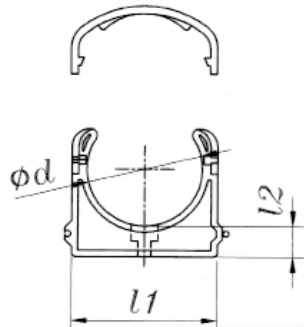

ITEM CODE Kod No	Ød Ød	l1(mm) l1(mm)	l2(mm) l2(mm)	Pcs/pkg Adet/Paket
04039050	50	62	13	60
04039070	75	95	20	100
04039100	110	135	20	45
04039125	125	155	30	100
04039150	160	195	40	50

PVC-U WASTE WATER PIPE AND FITTINGS

ITEM CODE Kod No	Ød Ød	Pcs/pkg Adet/paket
04031050	50	1
04031070	75	1
04031100	110	1
04031125	125	1
04031150	160	1
04031200	200	1
04031250	250	1

ITEM CODE Kod No	Ød Ød	Pcs/pkg Adet/paket
04032100	100	1

ITEM CODE Kod No	Ød Ød	Pcs/pkg Adet/paket
04034040	40	1
04034050	50	1

ITEM CODE Kod No	Ød Ød	l1(mm) l1(mm)	Pcs/pkg Adet/paket
04041100	110	125	40

PIPE GASKET
BORU CONTASI
Прокладка для ПВХ труб
جوان



KADA GASKET
KADA CONTA
Прокладка для перехода
جوان



SINK GASKET
LAVABO CONTASI
Прокладка для слива
جوان للمغاسل



KADA (S SYPHON LENGTHENING PIPE)
KADA
Переход-адаптор
أنبوب لتطويل سيفون

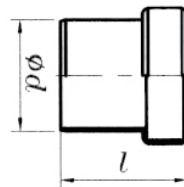

PVC-U PIPES (TYPE 2)

PVC-U WASTE WATER PIPES
PVC-U PİS SU BORULARI

ПВХ труба для сточных вод
انبوب بي في سي



ITEM CODE	Nominal Diameter	Outside Diameter	Type	Length (mm)	Pcs/Pkg
Kod No	Anma Çapı	Dış Çap Ød (mm)	Tip	Boy (mm)	Adet/Paket

050010500150	50	50	B	150	100
050010500250	50	50	B	250	75
050010500500	50	50	ÖA	500	10
050010501000	50	50	ÖA	1000	10
050010502000	50	50	ÖA	2000	10
050010503000	50	50	ÖA	3000	10
050010506000	50	50	ÖA	6000	1
050010700150	70	75	BD	150	60
050010700250	70	75	BD	250	35
050010700500	70	75	ÖA	500	10
050010701000	70	75	ÖA	1000	10
050010702000	70	75	ÖA	2000	1
050010703000	70	75	ÖA	3000	1
050010706000	70	75	ÖA	6000	1
050011000150	100	110	BD	150	10
050011000250	100	110	BD	250	20
050011000500	100	110	ÖA	500	10
050011001000	100	110	ÖA	1000	10
050011002000	100	110	ÖA	2000	1
050011003000	100	110	ÖA	3000	1
050011006000	100	110	ÖA	6000	1
050011250150	125	125	ÖA	150	20
050011250250	125	125	ÖA	250	13
050011250500	125	125	ÖA	500	7
050011251000	125	125	ÖA	1000	7
050011252000	125	125	ÖA	2000	1
050011253000	125	125	ÖA	3000	1
050011256000	125	125	ÖA	6000	1

ITEM CODE	Nominal Diameter	Outside Diameter	Type	Length (mm)	Pcs/Pkg
Kod No	Anma Çapı	Dış Çap Ød (mm)	Tip	Boy (mm)	Adet/Paket

050011500150	150	160	B	150	9
050011500250	150	160	B	250	9
050011500500	150	160	B	500	4
050011501000	150	160	B	1000	4
050011502000	150	160	B	2000	1
050011503000	150	160	B	3000	1
050011506000	150	160	B	6000	1
050012500150	200	200	B	150	6
050012500250	200	200	B	250	6
050012500500	200	200	B	500	3
050012501000	200	200	B	1000	3
050012502000	200	200	B	2000	1
050012503000	200	200	B	3000	1
050012506000	200	200	B	6000	1
040012000150	250	250	B	150	5
040012000250	250	250	B	250	5
040012000500	250	250	B	500	3
040012001000	250	250	B	1000	3
040012002000	250	250	B	2000	1
040012003000	250	250	B	3000	1
040012006000	250	250	B	6000	1

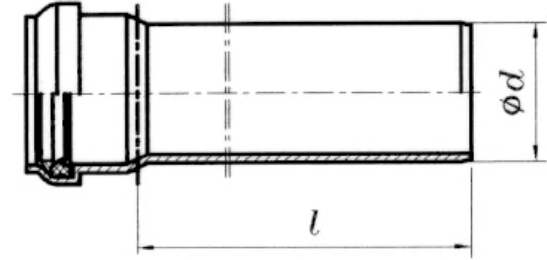

EGE PP TYPE B WASTE WATER PIPE AND FITTINGS

EGE PP BORU VE EK PARÇALARI (B TİPİ)

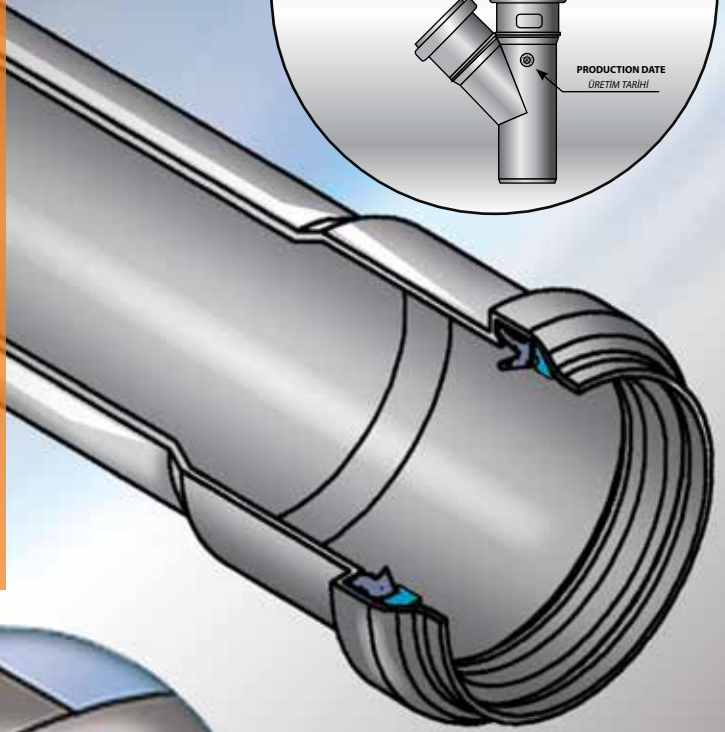
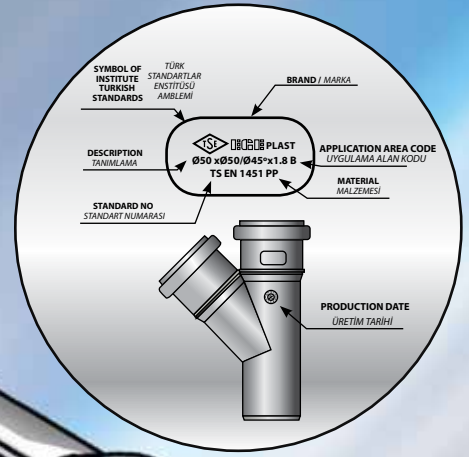

EGE PP PIPE/CROSSSECTION
EGE PP BORU/ ARA KESİT

USING AREAS

In the waste water system for the discharge of the houses' cold and hot waste water.

In the ventilation systems for the houses' waste water.

At the inside the building for the rain water systems.

KULLANIM ALANLARI

Sıcak ve soğuk evsel atıkların tahliyesinde kullanılan atık su şebekesinde,
Evsel atık su şebekeleri için havalandırma sistemlerinde

Bina içi yağmur suyu şebekelerinde kullanılır.



TS EN ISO 9001:2000



THE SUPERIORITIES OF EGE PP IN HOUSE WASTE WATER PIPES AND FITTINGS

1. EGE PP pipes and fittings are marked with the real production standard code "TS EN 1451" and they comply with all properties of the standard. They have TSE qualification certificates.
2. While EGE PP PIPES have stable gaskets and segments (special for Egeplast), the fittings are locked with gasket systems. Both systems have superior advantages than competitors.
3. Ø75 and Ø110 mm pipes bracelets provide cheaper and easier mounting. 50 mm bracelets can also be adjusted to 40 mm bracelets. They should be used with 1-1.5 meter intervals.
4. Thanks to pipe supports designed specially, the deformation during the storage can be stopped. At the same time EGE PP pipes need less storage area and they can be easily carried and handled.
5. Fittings are packed in the special boxes that allow less storage area and prevent fittings from deformation.
6. Because of low E Modulus of raw material, EGE PP pipes have lower noise level than conventional materials.
7. EGE PP pipes and fittings are unbreakable. Safer during transport, handling, storage and installation.
8. As a result of the perfect smoothness of inner surface, EGE PP pipes and fittings are free from lime and deposits.
9. Sealing gaskets comply with the standard TS EN 681-1 and are resistant to ozone and disposals.
10. EGE PP pipes are resistant to chemical corrosion for very wide Ph range i.e. waste water, rain water, surface and underground water. The information about the chemical resistance can be found in our web site. This information is prepared according to TS 11448.

EGE PP BİNA İÇİ ATIK SU BORU VE EK PARÇALARININ ÜSTÜNLÜKLERİ

1. EGE PP Boru ve Ek Parçaları üzerine gerçek ürün standartı numarası olan TS EN 1451 işaretlemesi mevcut olup, bu standartın gerektirdiği bütün özelliklere uygundur. Bu konuda TSE Kalite belgesine sahiptir.
2. EGE PP Boru ve Ek Parçaları sabit sistemdir. Borularda Ege Plast'a özgü sabit conta ve segman ile, ek parçalarda ise kilitlemeli sistem ile sabitlenmiştir. Bu sistem sayesinde benzerleriyle kıyaslanmayacak derecede üstünlüğe sahiptir.
3. Bu sistem için geliştirilen Ø75'lik ve Ø110'luk boru kelepçeleri ekonomik ve kolay montaj özelliği sağlarlar. Ø50'lik kelepçeler Ø40 için de ayarlanabilir. 1-1,5 metre arayla kullanılmalıdır.
4. Boru destekleri sayesinde boru ambalaj şekli bir ildir. Bu sayede az stok sahası, kolay istif, kolay taşıma, stokta duran borularda meydana gelebilecek deformasyon önlenmiştir.
5. Türkiye'de ilk defa ek parça kutu ambalajında olup, istifi, depolanması, taşınması kolaydır. Ek parçalar deformasyona uğramaz.
6. Binalarda atık su tesisatlarında suyun serbest düşme nedeniyle ses oluşturduğu bilinmektedir. EGE PP Boru ve Ek Parçaları (Malzemenin E modülü düşük olması nedeniyle) binalarda sesi minimuma indirir.
7. Kırılmazdır. Nakliye, depolama, montaj sırasında sorun çıkarmaz.
8. EGE PP Boru ve Ek Parçaları düşük iç yüzey pürüzlülüğü sebebiyle kireç ve tortu tutmaz.
9. Sızdırmazlık conta malzemesi TS EN 681-1'e uygun kalitede olup, ozona ve atıklara karşı dayanıklı olması nedeniyle uzun yıllar sızdırmazlıklarını korurlar.
10. EGE PP Boru ve Ek Parça Sistemleri, pis su, atık su, yağmur suyu, yüzey suyu ve zemin suyu gibi çok geniş bir PH aralığına dağılmış pek çok su tipi için kimyasal korozyona dirençlidir. Kimyasallara dayanım ile ilgili özellikler TS 11448 Standartına uygun olarak web sitemizde bulunmaktadır.
11. Tüm boru çapları ve zengin ek parça serisine sahiptir.

EGE PP PIPES AND FITTINGS (B TYPE) WALL THICKNESS TABLE

EGE PP BORU VE EK PARÇALARI (B TİPİ) ET KALINLIKLARI TABLOSU

OUTSIDE DIAMETER (mm) BORU DIŞ ÇAPI (mm)	WALL THICKNESS (mm) ET KALINLIĞI MİN. (mm)
Ø 40	1.80 mm
Ø 50	1.80 mm
Ø 75	1.90 mm
Ø 110	2.70 mm

**CASSETTE PACKING
QUANTITIES
KASET AMBALAJ
MİKTARLARI**

Ød (mm) Dış Çap	Length (mm) Boy (mm)	Type Tip	PCS/ CASSETTE Adet/ Kaset
40	500	B	25
40	1000	B	25
40	2000	B	25
40	3000	B	25
40	6000	B	25
50	500	B	25
50	1000	B	25
50	2000	B	25
50	3000	B	25
50	6000	B	25
75	500	B	20
75	1000	B	20
75	2000	B	20
75	3000	B	20
75	6000	B	20
110	500	B	15
110	1000	B	15
110	2000	B	15
110	3000	B	15
110	6000	B	15

EGE PP Pipes provide serious advantages in stocking with the packing system of cassettes and boxes, transportation and presentation to the clients.

In each cassette

50 mm pipes 25 PCS
75 mm pipes 20 PCS
110 mm pipes 15 PCS

EGE PP fittings are presented in the boxes.

EGE PP Borular Kaset- ambalaj şeklinde gerçekleştirilen ambalaj sistemi ile stoklamada, taşımada ve müşteriye sunumda ciddi avantajlar sağlamaktadır. Boru destekleri sayesinde ise az stok sahası, kolay istif, kolay taşıma, stokta duran borularda deformasyon önlenmiştir.

Her kasette

Ø50 mm borular 25 adet
Ø75 mm borular 20 adet
Ø110 mm borular 15 adet

EGE PP Boruların Ek Parçaları da kutu içinde sunulmaktadır.

**BOX PACKING
QUANTITIES
KUTU AMBALAJ
MİKTARLARI**

Ød (mm) Dış Çap	Length (mm) Boy (mm)	Type Tip	PCS/ CASSETTE Adet/ Kutu
40	150	B	70
40	250	B	45
50	150	B	40
50	250	B	25
75	150	B	32
75	250	B	22
110	150	B	15



EGE PP TYPE B WASTE WATER PIPE AND FITTINGS

EGE PP PIPES (EXTRUSION)
EGE PP BORULAR (EKSTRÜZYON)
ПП труба для сточных вод (тип В)
انبوب الصرف الصحي

ITEM CODE	Outside Diameter	Type	Length(mm)	Pcs/Pkg
Kod No	Dış Çap Ød(mm)	Tip	L-Boy(mm)	Adet/Kaset
057010400500BZ	40	B	500	25
057010401000BZ	40	B	1000	25
057010402000BZ	40	B	2000	25
057010403000BZ	40	B	3000	25
057010406000BZ	40	B	6000	25
057010500500BZ	50	B	500	25
057010501000BZ	50	B	1000	25
057010502000BZ	50	B	2000	25
057010503000BZ	50	B	3000	25
057010506000BZ	50	B	6000	25
057010700500BZ	75	B	500	20
057010701000BZ	75	B	1000	20
057010702000BZ	75	B	2000	20
057010703000BZ	75	B	3000	20
057010706000BZ	75	B	6000	20
057011000500BZ	110	B	500	15
057011001000BZ	110	B	1000	15
057011002000BZ	110	B	2000	15
057011003000BZ	110	B	3000	15
057011006000BZ	110	B	6000	15

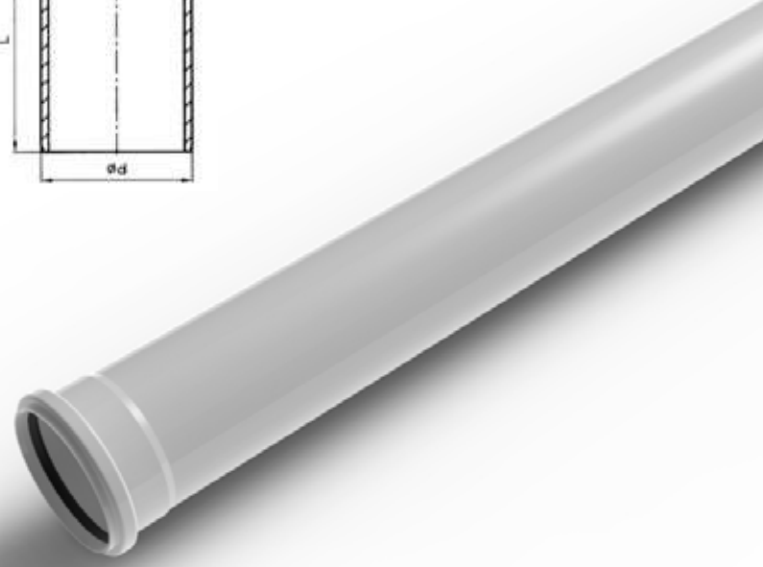
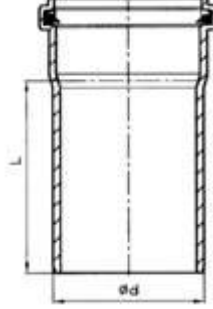

EGE PP PIPES (INJECTION)
EGE PP BORULAR (ENJEKSİYON)
ПП труба для сточных вод -инъекция (тип В)
انبوب الصرف الصحي

ITEM CODE	Outside Diameter	Type	Length(mm)	Pcs/Pkg
Kod No	Dış Çap Ød(mm)	Tip	L-Boy (mm)	Adet/Kutu
057010400150BZ	40	B	150	70
057010400250BZ	40	B	250	45
057010500150BZ	50	B	150	40
057010500250BZ	50	B	250	25
057010700150BZ	75	B	150	32
057010700250BZ	75	B	250	22
057011000150BZ	110	B	150	15
057011000250BZ	110	B	250	15

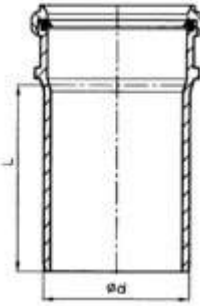

EGE PP TYPE B WASTE WATER PIPE AND FITTINGS

EGE PP ELBOW 45 °
EGE PP DİRSEK 45 °
ПВХ угольник 45°
45° كوع

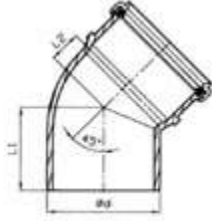

ITEM CODE Kod No	Ød Ød	Type Tip	L1(mm) L1(mm)	L2(mm) L2(mm)	Pcs/pkg Adet/paket
05737040BZ	40	B	56	13	100
05737050BZ	50	B	61	16	60
05737070BZ	75	B	72	21	40
05737100BZ	110	B	87	29	18

EGE PP ELBOW 87,5 °
EGE PP DİRSEK 87,5 °
ПП угольник 87,5° (тип В)
87,5° كوع

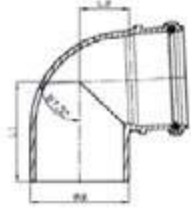

ITEM CODE Kod No	Ød Ød	Type Tip	L1(mm) L1(mm)	L2(mm) L2(mm)	Pcs/pkg Adet/paket
05738040BZ	40	B	65	25	100
05738050BZ	50	B	77	31	50
05738070BZ	75	B	94	43	35
05738100BZ	110	B	119	61	18

EGE PP SINGLE BRANCH 45 °
EGE PP TEK ÇATAL 45 °
ПВХ тройник 45°
وصله تجميع 45°

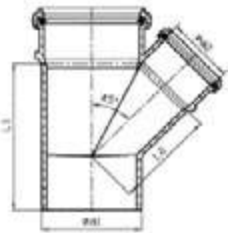

ITEM CODE Kod No	Ød1 Ød1	Ød2 Ød2	Type Tip	L1(mm) L1(mm)	L2(mm) L2(mm)	Pcs/pkg Adet/paket
057300400040BZ	40	40	B	105	51	50
057300500050BZ	50	50	B	122	61	25
057300700050BZ	75	50	B	127	79	25
057300700070BZ	75	75	B	163	91	25
057301000050BZ	110	50	B	136	104	16
057301000070BZ	110	75	B	172	116	10
057301000100BZ	110	110	B	221	134	7

EGE PP TYPE B WASTE WATER PIPE AND FITTINGS

EGE PP SINGLE BRANCH 87,5°
EGE PP TEK ÇATAL 87,5°
ПП тройник 87,5° (тип В)
تی 87,5°

ITEM CODE Kod No	Ød1 Ød1	Ød2 Ød2	Type Tip	L1(mm) L1(mm)	L2(mm) L2(mm)	Pcs/pkg Adet/paket
057290400040BZ	40	40	B	89	24	50
057290500050BZ	50	50	B	107	30	30
057290700050BZ	75	50	B	111	42	30
057290700070BZ	75	75	B	137	43	19
057291000050BZ	110	50	B	121	59	15
057291000070BZ	110	75	B	145	60	15
057291000100BZ	110	110	B	181	62	10

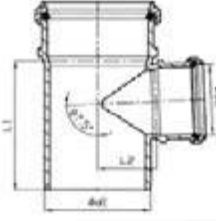

EGE PP DOUBLE BRANCH 45°
EGE PP ÇİFT ÇATAL 45°
ПП крестовина 45° (тип В)
وصله تجميع مزدوج

ITEM CODE Kod No	Ød1 Ød1	Ød2 Ød2	Type Tip	L1(mm) L1(mm)	L2(mm) L2(mm)	Pcs/pkg Adet/paket
057290400040BZ	40	40	B			
057290500050BZ	50	50	B	142	61	15
057290700070BZ	75	50	B	146	79	18
057290700070BZ	75	75	B	177	91	12
057291000050BZ	110	50	B	157	104	10
057291000070BZ	110	75	B	186	116	8
057291000100BZ	110	110	B	228	134	5

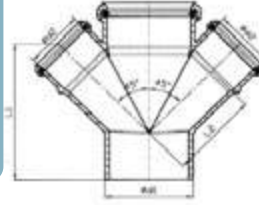

EGE PP COLLAR SLEEVE
EGE PP KAYAR MANŞON
ПП муфта (тип В)
وصله

ITEM CODE Kod No	Ød Ød	Type Tip	L1(mm) L1(mm)	Pcs/pkg Adet/paket
05717040BZ	40	B	88	100
05717050BZ	50	B	91	65
05717070BZ	75	B	107	50
05717100BZ	110	B	133	24

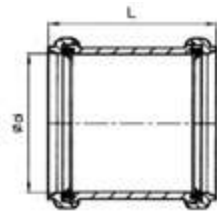

EGE PP TYPE B WASTE WATER PIPE AND FITTINGS

EGE PP REDUCER
EGE PP REDÜKSİYON
ПП переходник (тип В)

تخاص

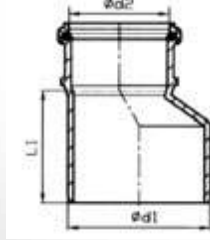

ITEM CODE Kod No	Ød1 Ød1	Ød2 Ød2	Type Tip	L1(mm) L1(mm)	Pcs/pkg Adet/paket
057190500040BZ	50	40	B	58	100
057190700050BZ	75	50	B	74	100
057191000050BZ	110	50	B	102	50
057191000070BZ	110	75	B	88	36

EGE PP CLEANOUT TEE
EGE PP TEMİZLEME TE
ПП ревизия (тип В)

تي مع فتحة تنظيف

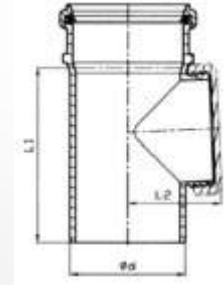

ITEM CODE Kod No	Ød Ød	Type Tip	L1(mm) L1(mm)	L2(mm) L2(mm)	Pcs/pkg Adet/paket
05744040BZ	40	B	89	48	40
05744050BZ	50	B	107	54	30
05744070BZ	75	B	137	64	20
05744100BZ	110	B	181	89	12

EGE PP "S" SYPHON
EGE PP "S" SİFON
ПП S сифон (тип В)

سیفون

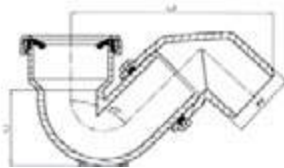

ITEM CODE Kod No	Ød Ød	Type Tip	L1(mm) L1(mm)	L2(mm) L2(mm)	Pcs/pkg Adet/paket
05743100BZ	110	B	136	342	5

EGE PP TYPE B WASTE WATER PIPE AND FITTINGS

EGE PP BRACELETTE
EGE PP KELEPÇE
ПП крепление
مربط

ITEM CODE Kod No	Ød(mm) Ød(mm)	b(mm) b(mm)	h(mm) h(mm)	L(mm) L(mm)	Pcs/Pkg Adet/Kutu
047390400050BZ	40	16	57	65	100
047390400050BZ	50	16	67	65	100

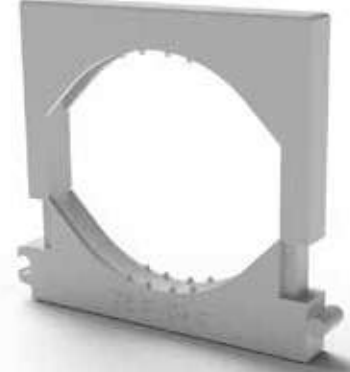
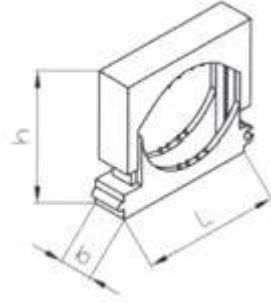

EGE PP BRACELETTE
EGE PP KELEPÇE
ПП крепление
مربط

ITEM CODE Kod No	Ød Ød	Pcs/pkg Adet/paket
04739070BZ	75	150
04739100BZ	110	130

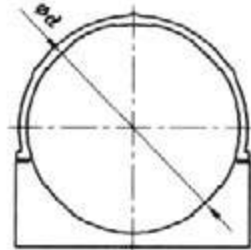

FIRE RESISTANT EGE PP PIPE AND FITTINGS

YANMAYA DAYANIKLI EGE PP BORU VE EK PARÇALARI (B TİPİ)

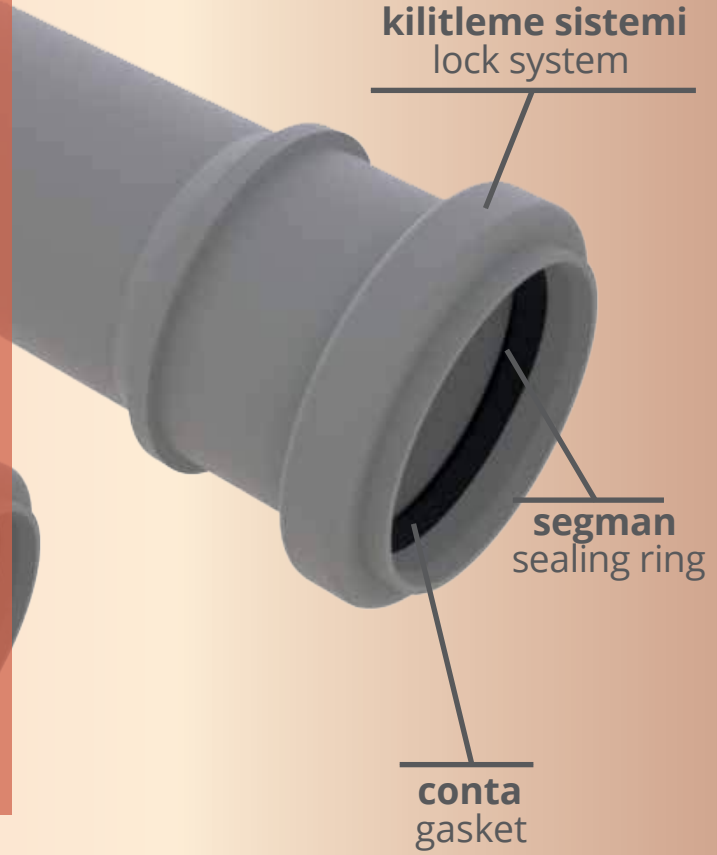

APPLICATION AREAS / KULLANIM ALANLARI

- Sıcak ve soğuk evsel atıkların tahliyesinde kullanılan atık su şebekesinde,
- Discharge of both hot and cold waste water in waterworks of buildings.
- Evsel atık su şebekeleri için havalandırma sistemlerinde
- In ventilation of buildings' waste water networks
- Bina içi yağmur suyu şebekelerinde kullanılır.
- Indoor rain water networks

TÜRKİYEDE İLK ve TEK
First in Turkey

YANMAYA
DAYANIKLI BORU



TS EN ISO 9001:2000





Yapı mevzuatına uygun, yanmaya dayanıklı boru. Yanıcılık Sınıfı TS EN 13501-1 C sınıfıdır. (DIN4102B1).
Proper to building regulations and it is fire resistant. Flammability class is TS EN 13501-1 C (DIN4102B1)



Yanmazlık katkılı, %100 blok kopolimer polipropilen hammaddesinden üretilmiştir, katkı maddesi içermez. Boru rengi açık gri'dir. Manufactured from 100% polypropylene block copolymer and does not consist any additives except the additive for incombustibility. The color of the pipe is light grey.



Kırılmaz, darbelere karşı dayanıklıdır, esnektir. Break-proof, impact resistant, flexible.



Yanmaya dayanıklı ege pp boruları atık suyun tahliyesi sırasında oluşan sesi esnek yapısı sayesinde engelleyerek sessizlik sağlar. Fire resistant Ege PP Pipes restrain the noise during the discharge of water in consequence of its flexible structure.



Yanmaya dayanıklı ege pp boruları ani sıcaklık değişimlerine uyum sağlar. Fire resistant Ege PP Pipes ensure adaptation against sudden temperature changes.



Yanmaya dayanıklı ege pp boruları çevre dostudur. Zehirli gaz çıkarmaz. Fire resistant Ege PP pipes are environment-friendly. It does not emit toxic gases.



Kilit sistemi sayesinde tam bir sızdırmazlık sağlar. Thanks to the lock system, it provides absolute leakproofness.



Kolay taşınabilir montajı basittir ve hafiftir. Easiness in both carrying and installation, it is lightweight.



Kullanılan hammaddenin özelliği sayesinde, kimyasal atıkların tahliyesi sorunsuz gerçekleşir. problem-free discharge of chemical wastes due to the character of raw material

FIRE RESISTANT PP PIPES AND FITTINGS

YANMAYA DAYANIKLI BORU EGE PP BORU VE EK PARÇALARI (B TİPİ) ET KALINLIKLARI TABLOSU

Outside Diameter BORU DIŞ ÇAPI (mm)	WALL THICKNESS (mm) ET KALINLIĞI MİN. (mm)
Ø 40	1.80 mm
Ø 50	1.80 mm
Ø 75	1.90 mm
Ø110	2.70 mm

BOX PACKING QUANTITIES

KUTU AMBALAJ MİKTARLARI

Outside Diameter Ød(mm) DIŞ ÇAP	Length (mm) BOY (mm)	Type TİP	Pcs Cassette ADET/ KASET
40	150	B	70
40	250	B	45
50	150	B	40
50	250	B	25
75	150	B	32
75	250	B	22
100	150	B	15
100	250	B	15

CASSETTE PACKING QUANTITIES

KASET AMBALAJ MİKTARLARI

Outside Diameter Ød(mm) DIŞ ÇAP	Length (mm) BOY (mm)	Type TİP	Pcs Cassette ADET/ KASET
40	500	B	25
40	1000	B	25
40	2000	B	25
40	3000	B	25
40	6000	B	25
50	500	B	25
50	1000	B	25
50	2000	B	25
50	3000	B	25
50	6000	B	25
75	500	B	20
75	1000	B	20
75	2000	B	20
75	3000	B	20
75	6000	B	20
110	500	B	15
110	1000	B	15
110	2000	B	15
110	3000	B	15
110	6000	B	15



FIRE RESISTANT EGE PP PIPES AND FITTINGS

EGE PP PIPES (EXTRUSION)
EGE PP BORULAR (YANGINA DAYANIKLI EKS.)

ПП труба для сточных вод
أنبوب الصرف الصحي

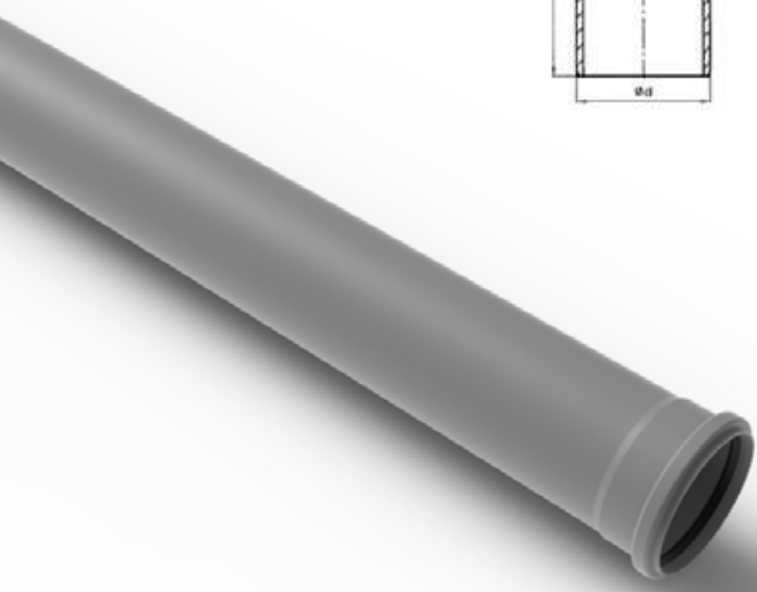
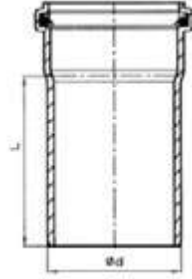

ITEM CODE	Outside Diameter	Type	Length(mm)	Pcs/Pkg
Kod No	Dış Çap Ød(mm)	Tip	L-Boy(mm)	Adet/Kaset
057010400500Y	40	B	500	25
057010401000Y	40	B	1000	25
057010402000Y	40	B	2000	25
057010403000Y	40	B	3000	25
057010406000Y	40	B	6000	25
057010500500Y	50	B	500	25
057010501000Y	50	B	1000	25
057010502000Y	50	B	2000	25
057010503000Y	50	B	3000	25
057010506000Y	50	B	6000	25
057010700500Y	75	B	500	20
057010701000Y	75	B	1000	20
057010702000Y	75	B	2000	20
057010703000Y	75	B	3000	20
057010706000Y	75	B	6000	20
057011000500Y	110	B	500	15
057011001000Y	110	B	1000	15
057011002000Y	110	B	2000	15
057011003000Y	110	B	3000	15
057011006000Y	110	B	6000	15

EGE PP PIPES (INJECTION)
EGE PP BORULAR (ENJ. YANGINA DAYANIKLI)

ПП труба для сточных вод -инъекция
أنبوب الصرف الصحي

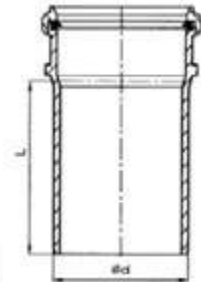

ITEM CODE	Outside Diameter	Type	Length(mm)	Pcs/Pkg
Kod No	Dış Çap Ød(mm)	Tip	L-Boy (mm)	Adet/Kutu
057010400150Y	40	B	150	70
057010400250Y	40	B	250	45
057010500150Y	50	B	150	40
057010500250Y	50	B	250	25
057010700150Y	75	B	150	32
057010700250Y	75	B	250	22
057011000150Y	110	B	150	15
057011000250Y	110	B	250	15

FIRE RESISTANT EGE PP PIPES AND FITTINGS

ITEM CODE Kod No	Ød Ød	Type Tip	L1(mm) L1(mm)	L2(mm) L2(mm)	Pcs/pkg Adet/paket
05737040Y	40	B	56	13	100
05737050Y	50	B	61	16	60
05737070Y	75	B	72	21	40
05737100Y	110	B	87	29	18

EGE PP ELBOW 45°
EGE PP DİRSEK 45° (YAN. DAY.)
ПП угольник 45°
45° كوع

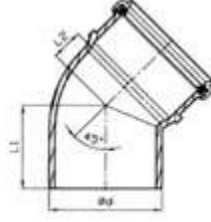

ITEM CODE Kod No	Ød Ød	Type Tip	L1(mm) L1(mm)	L2(mm) L2(mm)	Pcs/pkg Adet/paket
05738040Y	40	B	65	25	100
05738050Y	50	B	77	31	50
05738070Y	75	B	94	43	35
05738100Y	110	B	119	61	16

EGE PP ELBOW 87,5°
EGE PP DİRSEK 87,5° (YAN. DAY.)
ПП угольник 87,5°
87,5° كوع

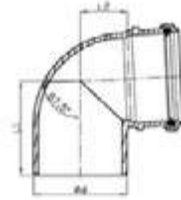

ITEM CODE Kod No	Ød1 Ød1	Ød2 Ød2	Type Tip	L1(mm) L1(mm)	L2(mm) L2(mm)	Pcs/pkg Adet/paket
057300400040Y	40	40	B	105	51	50
057300500050Y	50	50	B	122	61	25
057300700050Y	75	50	B	127	79	25
057300700070Y	75	75	B	163	91	25
057301000050Y	110	50	B	136	104	16
057301000070Y	110	75	B	172	116	10
057301000100Y	110	110	B	221	134	7

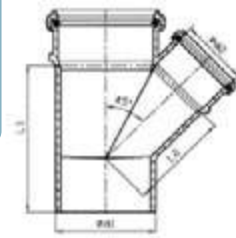

EGE PP SINGLE BRANCH 45°
EGE PP TEK ÇATAL 45° (YAN. DAY.)
ПП тройник 45° (min B)
45° وصله تجميع



FIRE RESISTANT EGE PP PIPES AND FITTINGS

EGE PP SINGLE BRANCH 87,5°
EGE PP TEK ÇATAL 87,5°
ПП тройник 87,5° (mun B)
تی 87,5°

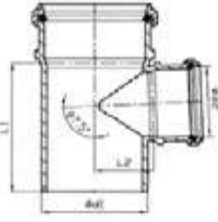

ITEM CODE Kod No	Ød1 Ød1	Ød2 Ød2	Type Tip	L1(mm) L1(mm)	L2(mm) L2(mm)	Pcs/pkg Adet/paket
057290400040Y	40	40	B	89	24	50
057290500050Y	50	50	B	107	30	30
057290700050Y	75	50	B	111	42	30
057290700070Y	75	75	B	137	43	19
057291000050Y	110	50	B	121	59	15
057291000070Y	110	75	B	145	60	15
057291000100Y	110	110	B	181	62	10

EGE PP DOUBLE BRANCH 45°
EGE PP ÇİFT ÇATAL 45°
ПП крестовина 45° (mun B)
وصله تجميع مزدوج

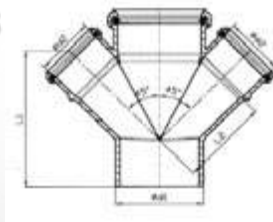

ITEM CODE Kod No	Ød1 Ød1	Ød2 Ød2	Type Tip	L1(mm) L1(mm)	L2(mm) L2(mm)	Pcs/pkg Adet/paket
057290400040Y	40	40	B			
057290500050Y	50	50	B	142	61	15
057290700070Y	75	50	B	146	79	18
057290700070Y	75	75	B	177	91	12
057291000050Y	110	50	B	157	104	10
057291000070Y	110	75	B	186	116	8
057291000100Y	110	110	B	228	134	5

EGE PP COLLAR SLEEVE
EGE PP KAYAR MANŞON
ПП муфта (mun B)
وصله

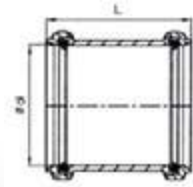

ITEM CODE Kod No	Ød Ød	Type Tip	L1(mm) L1(mm)	Pcs/pkg Adet/paket
05717040Y	40	B	88	40
05717050Y	50	B	91	65
05717070Y	75	B	107	50
05717100Y	110	B	133	24

FIRE RESISTANT EGE PP PIPES AND FITTINGS

EGE PP REDUCER
EGE PP REDÜKSİYON
ПП переходник
نقاص

ITEM CODE Kod No	Ød1 Ød1	Ød2 Ød2	Type Tip	L1(mm) L1(mm)	Pcs/pkg Adet/paket
057190500040Y	50	40	B	58	100
057190700050Y	75	50	B	74	100
057191000050Y	110	50	B	102	50
057191000070Y	110	75	B	88	36

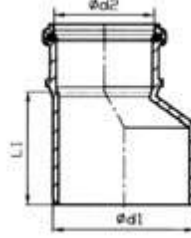

EGE PP CLEANOUT TEE
EGE PP TEMİZLEME TE
ПП ревизия
تي مع فتحة تنظيف

ITEM CODE Kod No	Ød Ød	Type Tip	L1(mm) L1(mm)	L2(mm) L2(mm)	Pcs/pkg Adet/paket
05744040Y	40	B	89	48	40
05744050Y	50	B	107	54	30
05744070Y	75	B	137	64	20
05744100Y	110	B	181	89	12

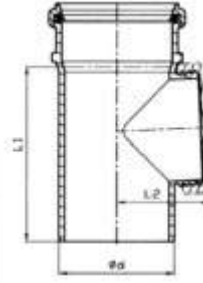

EGE PP "S" SYPHON
EGE PP "S" SIFON
ПП S сифон
سیفون

ITEM CODE Kod No	Ød Ød	Type Tip	L1(mm) L1(mm)	L2(mm) L2(mm)	Pcs/pkg Adet/paket
05743100Y	110	B	136	342	5

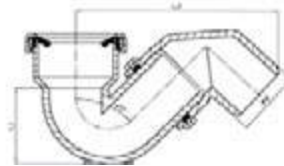

FIRE RESISTANT EGE PP PIPES AND FITTINGS

EGE PP BRACELETTE
EGE PP KELEPÇE (YAN. DAY.)
ПП крепление
مربط

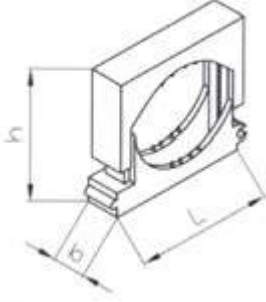
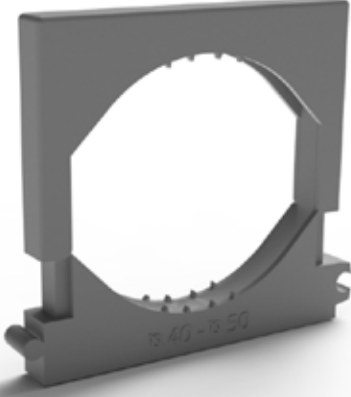

ITEM CODE Kod No	Ød(mm) Ød(mm)	b(mm) b(mm)	h(mm) h(mm)	L(mm) L(mm)	Pcs/Pkg Adet/Kutu
047390400050Y	40	16	57	65	100
047390400050Y	50	16	67	65	100

EGE PP BRACELETTE
EGE PP KELEPÇE (YAN. DAY.)
ПП крепление
مربط

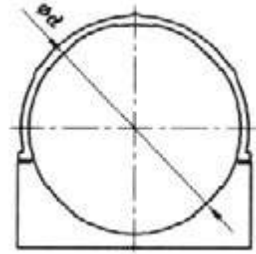

ITEM CODE Kod No	Ød Ød	Pcs/pkg Adet/paket
04739070Y	75	150
04739100Y	110	130

EGETHERM SIHHİ TESİSAT BORU VE PARÇALARI

Kullanım sahası bina içi basınçlı soğuk - sıcak su tesisatlarıdır.

Hammaddesi sıcaklığa ve basınca dayanıklı PP-R (Poli-propilen Random Kopolimer)'dir. SDR 6 PN 20, SDR 7.4 PN 16 ve SDR11 PN10 Basınç Sınıflarında, 4 metre boyda üretilmektedir.

Üretim aralığı borularda dış çap 20-160mm, ek parçalarda 20-110 mm'dir. Füzyotherm kaynak tekniği ile montajı kolay olup, işçilikten ve zamandan tasarruf sağlar. Montaj ile ilgili bilgiler Teknik Kitapçığımızda detaylı açıklanmıştır. Lineer Genleşme Katsayısı 0.15 mm/mK'dir.

EGETHERM FOLYOLU STABİL BORU

Kullanım sahası bina içi basınçlı sıcak su tesisatlarıdır. Hammaddesi sıcaklığa ve basınca dayanıklı PP-R (Poli-propilen Random Kopolimer)'dir.

SDR6 PN25 Basınç Sınıfında, 4 metre boyda üretilmektedir.

Üretim aralığı borularda dış çap 20-50 mm'dir. Egetherm ekparçalarla birlikte kullanılır.

Füzyotherm kaynak tekniği ile montajı kolay olup, işçilikten ve zamandan tasarruf sağlar.

Montaj ile ilgili bilgiler Teknik Kitapçığımızda detaylı açıklanmıştır.

Alüminyum folyo sayesinde Lineer Genleşme Katsayısı 0.030 mm/mK'dir.

TÜM EGETHERM BORULARIN ORTAK ÖZELLİKLERİ

İçme suyuna zararı yoktur. Suyun rengini, kokusunu veya tadını değiştirmez. Hijyeniktir ve Sağlık Bakanlığı tarafından onaylanmıştır.

Borular TS EN ISO 15874-2, ek parçalar TS EN ISO 15874-3 standardına uygun olup, TSE belgelidir.

EGETHERM SANITARY PIPES AND FITTINGS

Usage area is the pressurized hot and cold water systems in buildings Manufactured from PP-R (Poly Propylene Random Copolymer) resine which is resistant to heat and pressure.

Produced in SDR 6 PN 20, SDR 7.4 PN 16 and SDR 11 PN10 Pressure Classes, in net lengths of 4 meters. The production range for the pipes is from 20mm to 160mm outside diameter and 20-110 mm outside diameter for the fittings

Saves time and wokmanship since the installation is easy with fusiotherm welding technic

All necessary information about the installation is available in our detailed Technical Book.

The linear dilation Coefficient is 0.15 mm/mK

STABLE EGETHERM MULTILAYER PIPE WITH ALUMINIUM FOIL

Usage area is the pressurized hot water systems in buildings

Manufactured from PP-R (Poly Propylene Random Copolymer) resine which is resistant to heat and pressure

Produced in SDR6 PN25 Pressure Class, in net lengths of 4 meters.

The production range for the pipes is from 20 mm to 50mm and can be used with Egetherm fittings

Saves time and wokmanship since the installation is easy with fusiotherm welding technic

All necessary information about the installation is available in our detailed Technical Book.

The linear dilation Coefficient is 0.030 mm/mK with the help of the aluminium foil.

THE COMMON CHARACTERISTICS OF ALL EGETHERM PIPES

It has no negative effects on drinking water. Does not effect the color, the flavour or the taste of water. It is hygienic and approved by the Ministry of Health.

Technical Information

Teknik Bilgi

Техническая Информация

المعلومات الفنية

PP-R pipes are defined with either SDR or S (pipe series) according to the EN and DIN standards. These working conditions are given below according to the DIN 8077-78 with Safety Factor (SF) of 1,5.

EN ve DIN standartlarında PP-R borular SDR veya S (boru serisi) ile tanımlanmaktadır. Aşağıdaki tabloda PP-R Boruların TS EN ISO 15874-2 ve DIN 8077-8078 standartlarına göre çalışma şartları verilmiştir.

يتم التعريف بالضغط للأنابيب الحرارية بوحده SDR أو S وفقاً لمعايير EN أو DIN و. ونظراً لظروف عمل هذه الأنابيب عن طريق الرسوم البيانية في المعايير ونظراً لهذه الظروف العمل أدناه وفقاً لـ DIN 8077-78 ومعايير عوامل السلامة (SF) هو 1,5.

В стандартах EN и DIN трубы PP-R определяются показателями SDR или S (серия труб). Условия работы PP-R труб в разных температурах в соответствии с стандартом DIN 8077-78 (При условии Коэффициента безопасности (SF) = 1,5) указаны в таблице.

According to all relevant standards, there is no any difference between the Composite Pipes, Aluminum Foil Pipes and PP-R Straight Pipes by means of operating pressure classes.

İlgili tüm standartlara göre Alüminyum Folyolu Borular ve Düz Boruların çalışma basınç sınıflarında farklılık bulunmamaktadır.

Согласно соответствующим стандартам, нет никакой разницы между рабочими давлениями Обычных PP-R труб, Композитных труб и труб с Алюминиевой фольгой.

وفقاً للمعايير ذات الصلة، ليس هناك فرق بين الضغوط التشغيلية للمواسير، أنابيب الألومنيوم و الفبير جلاس و العادية

CLASS OF PIPES / BORU SERİSİ				
Operating Temperature Çalışma Sıcaklığı (°C)	Service Life İşletme Ömrü (year/yıl)	SDR 6 (S 2.5)	SDR 7.4 (S 3.2)	SDR 11 (S 5)
		Operating Pressure Çalışma Basıncı (PN)	Operating Pressure Çalışma Basıncı (PN)	Operating Pressure Çalışma Basıncı (PN)
20	100	20 Bar	16 Bar	10 Bar
60	50	10 Bar	8 Bar	6 Bar
70	50	8 Bar	6 Bar	4 Bar
80	25	6.5 Bar	5.1 Bar	3.2 Bar
95	10	4.3 Bar	3.4 Bar	2.2 Bar

EGE COMPOSITE PIPE

Usage area is the pressurized hot and cold water systems in buildings. The Composite pipe which has 3 layers, the mid-layer is glass-fiber reinforced PP-R resin and the inner and outer layers are PP-R (Poly Propylene Random Copolymer) produced in SDR6 PN25 and SDR7.4 PN20 Pressure Classes, in net lengths of 4 meters.

The production range for the pipes is from 20mm to 110mm. Egecomposite pipe can be used with Egetherm fittings.

Saves time and workmanship since the installation is easy with fusiotherm welding technic. Application of composite pipes is similar to Egetherm pipe installation technic. The linear dilation Coefficient is 0.035 mm/mK which is close to aluminium foiled pipe with the help of the glass-fiber reinforced PP-R mid-layer.

THE COMMON CHARACTERISTICS OF ALL EGETHERM PIPES

It has no negative effects on drinking water. Does not effect the color, the flavour or the taste of water. It is hygienic and approved by the Ministry of Health.

EGE KOMPOZİT BORU

Kullanım sahası bina içi basınçlı soğuk-sıcak su tesisatlarıdır.

Üç katmandan oluşan borunun orta katmanı cam elyaf takviyeli PP-R hammaddesi, iç ve dış katmanlar ise PP-R (Polipropilen Random Kopolimer)'dir. SDR6 PN25 ve SDR7.4 PN20 Basınç Sınıflarında, 4 metre boyda üretilmektedir.

Üretim aralığı borularda dış çap 20-110 mm'dir. Egetherm ekparçalarla birlikte kullanılır. Füzyootherm kaynak tekniği ile montajı kolay olup, işçilikten ve zamandan tasarruf sağlar.

Uygulaması Egetherm boru montajı ile aynıdır. Füzyootherm kaynak tekniği ile montajı kolay olup, işçilikten ve zamandan tasarruf sağlar.

Cam elyaf takviyeli orta katman sayesinde lineer genleşme katsayısı 0.035 mm/mK olup, alüminyum folyolu boruya yakın hale getirilmiştir.

EGETHERM KOMPOZİT BORULARIN ORTAK ÖZELLİKLERİ

İçme suyuna zararı yoktur. Suyun rengini, kokusunu veya tadını değiştirmez.

Hijyeniktir ve Sağlık Bakanlığı tarafından onaylanmıştır. TS 13715 standardına uygun olarak üretilmekte olup TSE belgelidir.

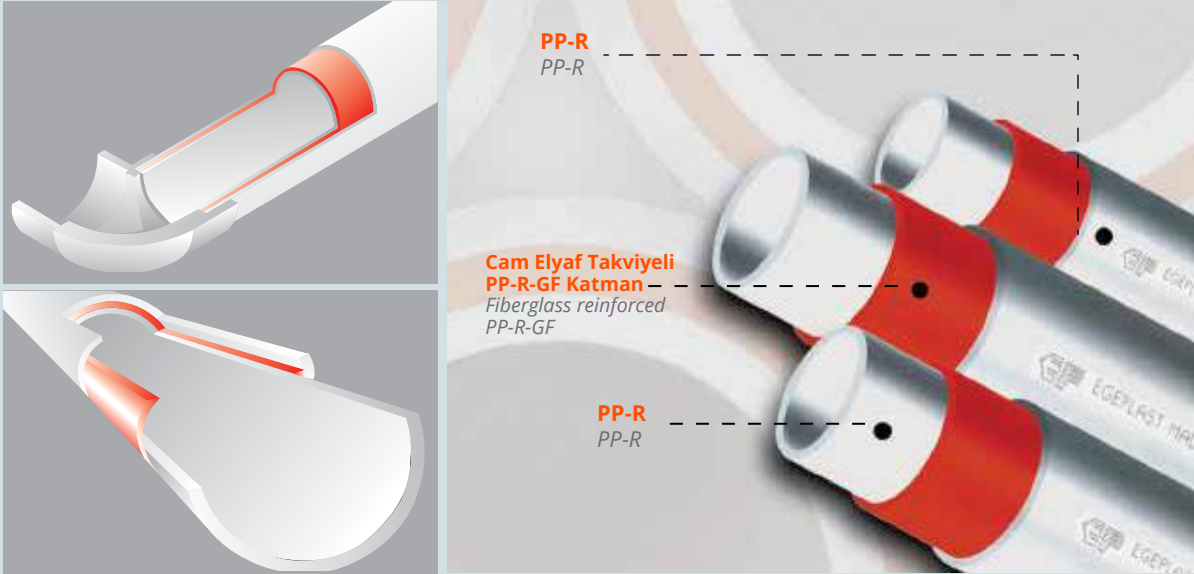

Working Temperature Çalışma sıcaklığı	Working Pressure Çalışma Basıncı	Service Life İşletme Ömrü
20 °C	25 Bar	100 Yıl / Years
60 °C	10 Bar	50 Yıl / Years
70 °C	8 Bar	50 Yıl / Years
95 °C	4,3 Bar	10 Yıl / Years

CLASS OF PIPES / BORU SERİSİ			
Operating Temperature Çalışma Sıcaklığı (°C)	Service Life İşletme Ömrü (year/yıl)	SDR 6 (S 2.5)	SDR 7.4 (S 3.2)
		Operating Pressure Çalışma Basıncı (PN)	Operating Pressure Çalışma Basıncı (PN)
20	100	25 Bar	20 Bar
60	50	10 Bar	8 Bar
70	50	8 Bar	6 Bar
80	25	6.5 Bar	5.1 Bar
95	10	4.3 Bar	3.4 Bar

PVC RAIN GUTTER AND DOWN PIPES

Egeplast Rain Gutter systems are in conformity with TS Norms and manufactured under the ISO 9000 Quality Management System.

Factors such as the appearance, the rain water charging and discharging capacity, easy installation and maximum quality are taken into consideration in the design process of Rain Gutters and its fittings.

The decorative look, easy handling and large portfolio of fittings are the most preferable features for both the end-user and installer.

100 RAIN GUTTER AND FITTINGS

100 mm Rain Gutter and Fittings are manufactured in conformity with TS EN 607 and their water flow capacity is 6,5 lt/m

150 RAIN GUTTER AND FITTINGS

150 Rain Gutter and Fittings are manufactured in conformity with TS EN 607 and their water flow capacity is 12 lt/m

100 ÇATI OLUĞU VE EK PARÇALARI

TS EN 607'ye uygun olarak üretilmekte olup, çatı oluğunun su taşıma kapasitesi 6,5lt./m'dir.

150 ÇATI OLUĞU VE EK PARÇALARI

TS EN 607'ye uygun olarak üretilmekte olup çatı oluğunun su taşıma kapasitesi 12 lt./m'dir.

EGETHERM SANITARY PIPES AND FITTINGS

EGETHERM PIPE (SDR6 PN 20)
EGETHERM BORU (SDR6 PN20)
Труба PPRC TYPE-3, PN20, SDR6
PN 20 **انابيب بي بي ار سي**



ITEM CODE Kod No	Ød(mm) Ød(mm)	s(mm) s(mm)	METER/PCS Metre/Paket
19002020	20	3.40	100
19002025	25	4.20	100
19002032	32	5.40	60
19002040	40	6.70	40
19002050	50	8.30	20
19002063	63	10.50	20
19002075	75	12.50	12
19002090	90	15.00	8
19002110	110	18.30	8
19002125	125	20.80	4
19002140	140	23.30	4
19002160	160	26.60	4

EGETHERM PIPE (SDR7.4 PN16)
EGETHERM BORU (SDR7.4 PN16)
Труба PPRC TYPE-3, PN16, SDR7.4
PN 16 **انابيب بي بي ار سي**



ITEM CODE Kod No	Ød(mm) Ød(mm)	s(mm) s(mm)	METER/PCS Metre/Paket
19002020	20	2.80	100
19002025	20	3.50	100
19002032	20	4.40	60
19002040	20	5.50	40
19002050	20	6.90	20
19002063	20	8.60	20
19002075	20	10.30	12
19002090	20	12.30	8
19002110	20	15.10	8
19002125	20	17.10	4
19002140	20	19.20	4
19002160	20	21.90	4

EGETHERM PIPE (SDR11 PN10)
EGETHERM BORU (SDR11 PN10)
Труба PPRC TYPE-3, PN10, SDR11
PN10 **انابيب بي بي ار سي**

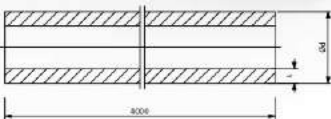

ITEM CODE Kod No	Ød(mm) Ød(mm)	s(mm) s(mm)	METER/PCS Metre/Paket
19002020	10	1.90	100
19002025	10	2.30	100
19002032	10	2.90	60
19002040	10	3.70	40
19002050	10	4.60	20
19002063	10	5.80	20
19002075	10	6.80	12
19002090	10	8.20	8
19002110	10	10.00	8
19002125	10	11.40	4
19002140	10	12.70	4
19002160	10	14.60	4

EGETHERM SANITARY PIPES AND FITTINGS

EGE COMPOSITE PIPE (SDR6 PN25)
EGE KOMPOZİT BORU (SDR6 PN25*)
Труба PPRC с армированием стекловолокном PN25, SDR6
انابيب اجيه المعزولة PN25

ITEM CODE Kod No	Ød(mm) Ød(mm)	s(mm) s(mm)	METER/PCS Metre/Paket
19502020	20	3.40	100
19502025	25	4.20	100
19502032	32	5.40	60
19502040	40	6.70	40
19502050	50	8.30	20
19502063	63	10.50	20
19502075	75	12.50	12
19502090	90	15.00	8
19502110	110	18.30	4

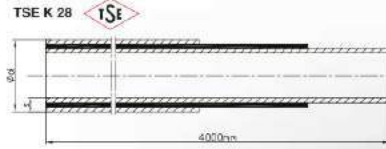

EGE COMPOSITE PIPE (SDR7.4 PN20)
EGE KOMPOZİT BORU (SDR7.4 PN20*)
Труба PPRC с армированием стекловолокном PN20, SDR7.4
انابيب اجيه المعزولة SDR7.4

ITEM CODE Kod No	Ød(mm) Ød(mm)	s(mm) s(mm)	METER/PCS Metre/Paket
19502020	20	2.80	100
19502025	25	3.50	100
19502032	32	4.40	60
19502040	40	5.50	40
19502050	50	6.90	20
19502063	63	8.60	20
19502075	75	10.30	12
19502090	90	12.30	8
19502110	110	15.10	8

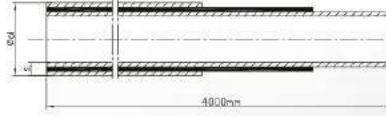

EGETHERM BLACK PIPE (SDR6 PN20)
EGETHERM SİYAH BORU (SDR6 PN20)
PPRC Чёрная Труба PN20, SDR6
الانابيب الحرارية السوداء

ITEM CODE Kod No	Ød(mm) Ød(mm)	s(mm) s(mm)	METER/PCS Metre/Paket
19002020 SY	20	3.40	100
19002025 SY	25	4.20	100
19002032 SY	32	5.40	60
19002040 SY	40	6.70	40
19002050 SY	50	8.30	20
19002063 SY	63	10.50	20
19002075 SY	75	12.50	12
19002090 SY	90	15.00	8
19002110 SY	110	18.30	4
19002125 SY	125	20.80	4
19002140 SY	140	23.30	4
19002160 SY	160	26.60	4

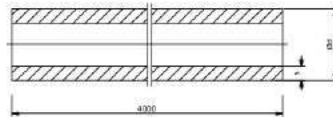

EGETHERM SANITARY PIPES AND FITTINGS

PIPE WITH ALUMINIUM FOIL (SDR6 PN25*)
FOLYOLU BORU (Deliksiz) (SDR6 PN25*)
PPRC Труба с армированием алюминием PN25, SDR6

25 İnanıyıp بی بی ار سی مع الالمنیوم

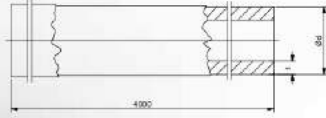
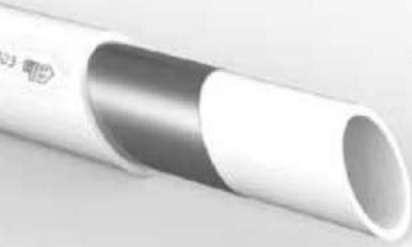

ITEM CODE Kod No	Ød(mm) Ød(mm)	s(mm) s(mm)	METER/PCS Metre/Paket
19500020	20	3.40	100
19500025	25	4.20	100
19500032	32	5.40	60
19500040	40	6.70	40
19002050	50	8.30	20

SOCKET
MANŞON
МУФТА
وطة

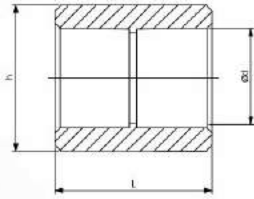

ITEM CODE Kod No	Ød Ød	L L	h h	PCS/BOX Adet/ Kutu
19003020	20	32	29	250
19003025	20	35	34	150
19003032	20	39	42	100
19003040	20	46	55	40
19003050	20	50	66	40
19003063	20	58	84	24
19003075	20	61	100	12
19003090	20			20
19003110	20			15

ELBOW 45°
DİRSEK 45°
УГОЛЬНИК 45°
45 كوع

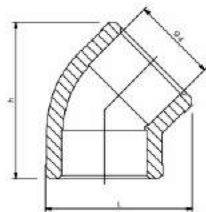

ITEM CODE Kod No	Ød Ød	L L	h h	PCS/BOX Adet/ Kutu
19005020	20	35	46	250
19005025	25	41	52	150
19005032	32	53	63	80
19005040	40	67	69	40
19005050	50	81	87	75
19005063	63	101	104	40
19005075	75			20
19005090	90			10
19005110	110			10

EGETHERM SANITARY PIPES AND FITTINGS

ITEM CODE Kod No	Ød Ød	L L	PCS/BOX Adet/ Kutu
19006020	20	39	150
19006025	25	42	100
19006032	32	62	40
19006040	40	79	30
19006050	50	81	24
19006063	63	102	8
19006075	75	119	6
19006090	90		10
19006110	110		6

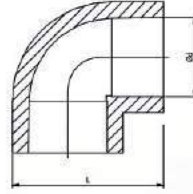

ELBOW 90 °
DİRSEK 90 °
УГОЛЬНИК 90°

كوع



ITEM CODE Kod No	Ød 1 Ød 1	Ød 2 Ød 2	PCS/BOX Adet/ Kutu
19058020	20	19,5	150
19058025	25	24,5	100
19058032	32	31,2	40

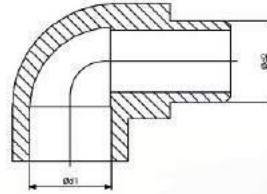

TAIL ELBOW 90 °
KUYRUKLU DİRSEK 90 °
УГОЛЬНИК ВН.Р / Н.Р

ذیل کوع



ITEM CODE Kod No	Ød Ød	L L	h h	PCS/BOX Adet/ Kutu
19010020	20	52	40	100
19010025	25	60	48	80
19010032	32	72	57	40
19010040	40	85	69	25
19010050	50	100	84	18
19010063	63	120	102	8
19010075	75	138	119	6
19010090	90			8
19010110	110			5

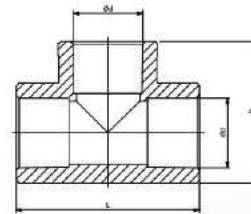

EQUAL TEE
EŞİT TE
ТРОЙНИК

تەڭ



EGETHERM SANITARY PIPES AND FITTINGS

REDUCING TEE
REDÜKSİYON TE
ТРОЙНИК РЕДУКЦИОННЫЙ
تي منقص

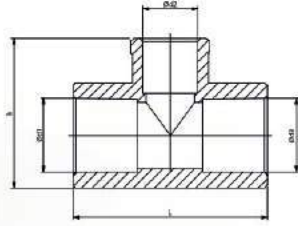
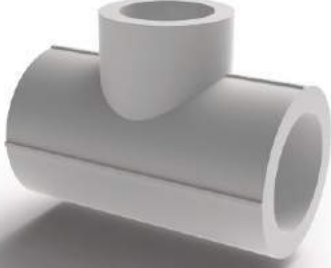

ITEM CODE Kod No	Ød1 Ød1	Ød2 Ød2	Ød3 Ød3	L L	h h	PCS/BOX Adet/ Kutu
190110252020	25	20	20	59	48	80
190110252025	25	20	25	59	48	80
190110322020	32	20	20	70	52	40
190110322032	32	20	32	70	52	40
190110322520	32	25	20	70	52	40
190110322532	32	25	32	70	52	40
190110402040	40	20	40	84	66	25
190110402540	40	25	40	84	66	25
190110403240	40	25	40	84	66	25
190110503240	50	32	40			50
190110503250	50	32	50			50
190110603263	63	32	63			8
190110634063	50	40	50			50
190110635063	63	50	63			20
190110756075	75	63	75			15
190110907590	90	75	90			10
1901111090110	110	90	110			5

PROTECTION CAP
KARAMA BAŞLIĞI
ЗАГЛУШКА
سدّة لجام

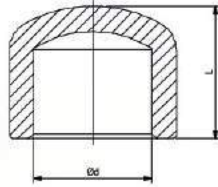

ITEM CODE Kod No	Ød Ød	L L	PCS/BOX Adet/ Kutu
19014020	20	22	500
19014025	25	25	200
19014032	32	28	100
19014040	40	33	100
19014050	50	38	60
19014063	63	53	40
19014075	75	57	40
19014090	90		30
190140110	110		20

THREADED ENDLUG
KÖRTAPA (DİŞLİ)
ЗАГЛУШКА С РЕЗЬБОЙ
سدّة بسن

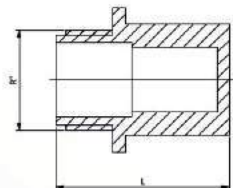

ITEM CODE Kod No	Ød Ød	R'' R''	L L	PCS/BOX Adet/ Kutu
190140200020	20	1/2	34	300
190140250025	25	3/4	37	250
190140320032	32	1		150

EGETHERM SANITARY PIPES AND FITTINGS

ITEM CODE Kod No	Ød Ød	L L	h h	PCS/BOX Adet/ Kutu
19631020	20	54	54	50
19631025	25	56	56	50
19631032	32	71	71	30

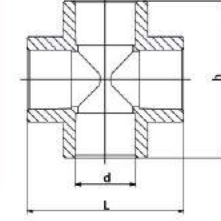

CROSS
İSTAVROZ
КРЕСТОВИНА
مجمع



ITEM CODE Kod No	Ød 1 Ød 1	Ød 2 Ød 2	L L	PCS/BOX Adet/ Kutu
190040250020	25	20	36	250
190040320020	32	20	40	150
190040320025	32	25	40	100
190040400020	40	20	43	100
190040400025	40	25	43	100
190040400032	40	32	45	100
190040500020	50	20	48	75
190040500025	50	25	49	40
190040500032	50	32	51	60
190040500040	50	40	53	40
190040630032	63	32	57	30
190040630040	63	40	60	30
190040630050	63	50	63	30
190040750050	75	50	67	24
190040750063	75	63	71	20
190040900063	90	63		5
190040900075	90	75		20
190041100075	110	75		10
190041100090	110	90		10

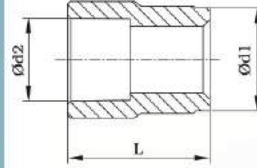

REDUCER
REDÜKSİYON
МУФТА ПЕРЕХОДНАЯ
نقاصة



ITEM CODE Kod No	Ød Ød	R" R"	L L	h h	PCS/BOX Adet/ Kutu
190180200020	20	1/2	38	39	150
190180200025	20	3/4	38	39	80
190180250020	25	1/2	42	39	100
190180250025	25	3/4	40	45	100
190180320020	32	1/2	46	54	30
190180320025	32	3/4	46	54	30
190180320032	32	1	46	54	50
190180400040	40	1 1/4	51	76	24
190180500040	50	1 1/4	66	75	24
190180500050	50	1 1/2	68	82	24
190180630050	63	1 1/2	72	84	10
190180630063	63	2	79	100	10
190180630075	75	2 1/2			8
190180630090	90	3			20
190181100110	110	4			

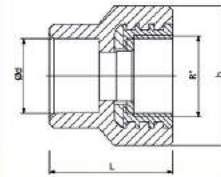

TRANSITION PIECE FEMALE THREADED
DiŞi ADAPTÖR
МУФТА КОМБИНИРОВАННАЯ ВН.Р
وطة مع سن أنثى



EGETHERM SANITARY PIPES AND FITTINGS

TRANSITION PIECE MALE THREADED
ERKEK ADAPTÖR
МУФТА КОМБИНИРОВАННАЯ Н.Р
وصلة مع سن ذكر

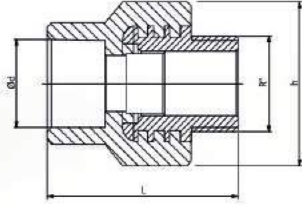

ITEM CODE Kod No	Ød1 Ød1	R" R"	L L	h h	PCS/BOX Adet/ Kutu
190190200020	20	1/2	51	39	100
190190200025	20	3/4	53	39	80
190190250020	25	1/2	56	39	80
190190250025	25	3/4	53	45	80
190190320020	32	1/2	60	54	30
190190320025	32	3/4	62	54	30
190190320032	32	1	63	54	50
190190400040	40	1 1/4	86	76	24
190190500040	50	1 1/4	87	75	20
190190500050	50	1 1/2	89	77	24
190190630050	63	1 1/2	93	84	11
190190630063	63	2	104	86	11
190190630075	75	2 1/2			8
190190630090	90	3			16
190191100110	110	4			

ELBOW FEMALE THREADED 90 °
DİŞİ DİRSEK 90 °
УГОЛ КОМБИНИРОВАННЫЙ ВН.Р
كوع أنثى بسن

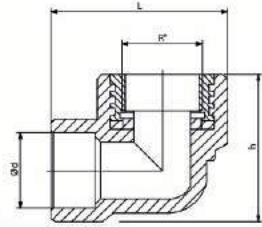

ITEM CODE Kod No	Ød1 Ød1	R" R"	L L	h h	PCS/BOX Adet/ Kutu
190070200020	20	1/2	45	50	100
190070200025	20	3/4	55	47	50
190070250020	25	1/2	54	54	80
190070250025	25	3/4	54	54	50
190070320020	32	1/2	73	61	30
190070320025	32	3/4	73	61	30
190070320032	32	1	73	61	30
190070400040	40	1 1/4	90	77	15

ELBOW MALE THREADED 90 °
ERKEK DİRSEK 90 °
УГОЛ КОМБИНИРОВАННЫЙ Н.Р
كوع ذكر بسن

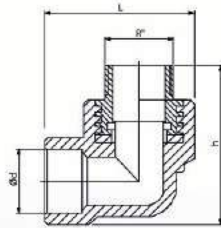

ITEM CODE Kod No	Ød1 Ød1	R" R"	L L	h h	PCS/BOX Adet/ Kutu
190080200020	20	1/2	45	63	100
190080200025	20	3/4	55	60	50
190080250020	25	1/2	54	68	80
190080250025	25	3/4	54	68	50
190080320020	32	1/2	73	77	30
190080320025	32	3/4	73	78	24
190080400032	32	1	73	80	20
190080400040	40	1 1/4	90	112	15

EGETHERM SANITARY PIPES AND FITTINGS

WALL BRACKET ELBOW 90° WITH FEMALE THREADED

DİŞİ BATARYA GİRİŞİ 90°

УГОЛ КОМБИНИР С КРЕПЛЕНИЕМ ВН Р

كوع نهاية خط بسن

ITEM CODE Kod No	Ød Ød	R" R"	L L	h h	PCS/BOX Adet/ Kutu
190090200020	20	1/2	44	47	80
190090250020	25	1/2	55	52	60

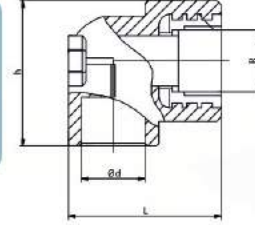

WALL BRACKET ELBOW 90° WITH MALE THREADED

ERKEK BATARYA GİRİŞİ 90°

УГОЛ КОМБИНИР С КРЕПЛЕНИЕМ Н Р

كوع نهاية خط ذكر بسن

ITEM CODE Kod No	Ød Ød	R" R"	PCS/BOX Adet/ Kutu
190490200020	20	1/2	200
190490250020	25	1/2	200

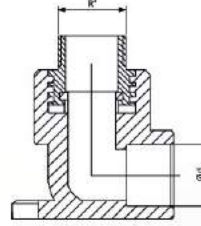

DUAL BATTERY CONNECTION

İKİLİ BATARYA BAĞLANTISI

ДВОЙНОЙ УГОЛ КОМБИНИР ВН.Р

بطارية الربط المزدوج

ITEM CODE Kod No	Ød Ød	R" R"	L L	PCS/BOX Adet/ Kutu
190560200020	20	1/2	150	20
190560250020	25	1/2	150	20

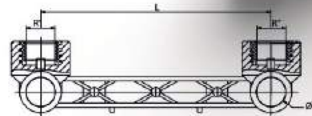

EGETHERM SANITARY PIPES AND FITTINGS

LUSTRATION BATTERY CONNECTION
TAHARET BATARYA BAĞLANTISI
КОМПЛЕКТ УНИВЕРСАЛЬНЫЙ НАСТЕННЫЙ
بطارية طهارة

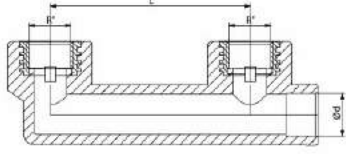

ITEM CODE Kod No	Ød Ød	R" R"	L L	PCS/BOX Adet/ Kutu
190570200020	20	1/2	90	30

TEE FEMALE THREADED
DİŞİ TE
ТРОЙНИК КОМБИНИРОВАННЫЙ ВН.Р
تي مسننة أنثى

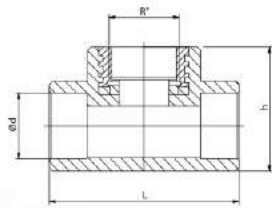

ITEM CODE Kod No	Ød Ød	R" R"	L L	h h	PCS/BOX Adet/ Kutu
190120202020	20	1/2	54	48	100
190120202520	20	3/4	54	48	40
190120252025	25	1/2	75	56	50
190120252525	25	3/4	75	56	40
190120322032	32	1/2	92	60	20
190120322532	32	3/4	92	60	20
190120323232	32	1	92	60	20
190120404040	40	1 1/4	107	81	18

TEE MALE THREADED
ERKEK TE
ТРОЙНИК КОМБИНИРОВАННЫЙ Н.Р
تي مسننة ذكر

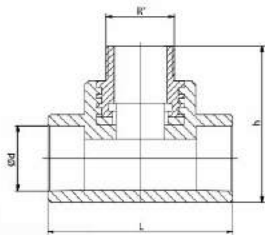

ITEM CODE Kod No	Ød Ød	R" R"	L L	h h	PCS/BOX Adet/ Kutu
190130202020	20	1/2	54	62	80
190130202520	20	3/4	54	67	40
190130252025	25	1/2	75	68	50
190130252525	25	3/4	75	72	40
190130322032	32	1/2	92	77	20
190130322532	32	3/4	92	79	15
190130323232	32	1	92	79	20
190120404040 U	40	1 1/4	107	101	12

EGETHERM SANITARY PIPES AND FITTINGS

BOWKNOT
FİYONG
КОМПЕНСАТОР
وصل نهمد

ITEM CODE Kod No	Ød Ød	L L	h h	PCS/BOX Adet/ Kutu
19015020	20	160	170	25
19015025	25	190	180	20
19015032	32	250	220	10
19015040	40	250	240	5

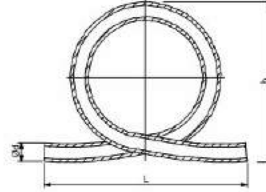

TRANSITION PIECE
RAKOR (Kaynaklı)
МУФТА РАЗЪЕМНАЯ
قطعة تحويل

ITEM CODE Kod No	Ød Ød	L L	h h	PCS/BOX Adet/ Kutu
19032020 U	20	56	54	50
19032025	25	46	60	20
19032032	32	52	68	20
19032040	40	60	83	20
19032050	50	72	96	20
19032063	63	87	116	6
19032075	75	-	-	6
19032090	90	-	-	10
19032110	110	-	-	6

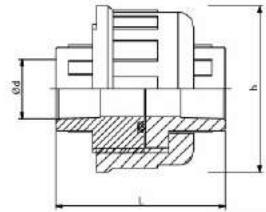

TRANSITION MUFF FEMALE THREADED
RAKOR (Dişli-Kaynaklı)
МУФТА РАЗЪЕМНАЯ РЕЗЬБОВАЯ
قطعة تحويل مسننة انثى

ITEM CODE Kod No	Ød Ød	R" R"	L L	h h	PCS/BOX Adet/ Kutu
1903202001	20	1/2	44	55	50
1903202501	25	3/4	-	-	200
1903203201	32	1	-	-	150
1903204001	40	1 1/4	-	-	50
1903205001	50	1 1/2	-	-	30
1903206301	63	2	-	-	20
1903207501	75	2 1/2	-	-	15
1903209001	90	3	-	-	10
1903211001	110	4	-	-	6

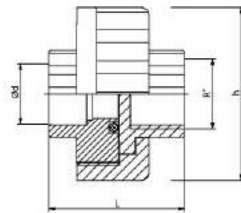

EGETHERM SANITARY PIPES AND FITTINGS

COUPLING SCREW JOINT FEMALE THREADED
OYNAR BAŞLI DIŞİ RAKOR
МУФТА РАЗЪЕМНАЯ КОМБИНИРОВАННАЯ ВН.Р
قطع وصل مسننة أنثى

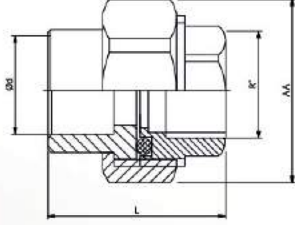
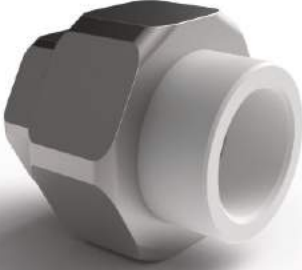

ITEM CODE Kod No	Ød Ød	R" R"	L L	AA AA	PCS/BOX Adet/ Kutu
190280200020	20	1/2	35	36	100
190280200025	20	3/4			100
190280200032	20	1			40
190280250025	25	3/4	38	45	50
190280250032	20	1			50
190280320025	32	3/4			40
190280320032	32	1	42	52	40
190280320040	32	1 1/4			40
190280420040	40	1 1/4	50	63	25
190280420050	50	1 1/2	51	79	20
190280630063	63	2	62	103	10
190280750075	75	2 1/2	-	-	6

COUPLING SCREW JOINT MALE THREADED
OYNAR BAŞLI ERKEK RAKOR
МУФТА РАЗЪЕМНАЯ КОМБИНИРОВАННАЯ Н.Р
قطع وصل مسننة ذكر

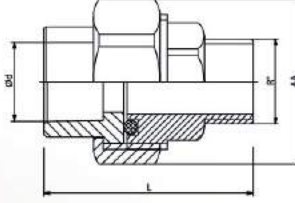

ITEM CODE Kod No	Ød Ød	R" R"	L L	AA AA	PCS/BOX Adet/ Kutu
190290200020	20	1/2	35	36	100
190290200025	20	3/4			100
190290200032	20	1			100
190290250025	25	3/4	49	45	50
190290250032	25	1			50
190290320025	32	3/4			30
190290320032	32	1	57	52	30
190290320040	32	1 1/4			30
190290400040	40	1 1/4	66	63	25
190290500050	50	1 1/2	67	79	20
190290630063	63	2	79	103	10
190290750075	75	2 1/2	-	-	8

NIPPLE LOOSE NUT
HAREKETLİ NİPEL
МУФТА С НАКИДНОЙ ГАЙКОЙ
أكرة وصل متحركة

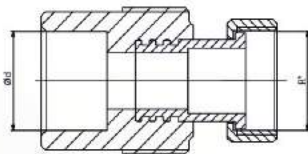

ITEM CODE Kod No	Ød Ød	R" R"	PCS/BOX Adet/ Kutu
190480200020	20	1/2	200
190480200025	20	3/4	100
190480250025	25	3/4	100
190480250032	25	1	50
190480320032	32	1	50
190480320040	32	1 1/4	40

EGETHERM SANITARY PIPES AND FITTINGS

RADIATOR VALVE STRAIGHT
RADYATÖR VANASI DÜZ
ВЕНТИЛЬ ДЛЯ РАДИАТОРА ПРЯМОЙ
سخان مستقيم

ITEM CODE Kod No	Ød Ød	R" R"	Pcs/pkg Adet/paket
190460200020	20	1/2	50

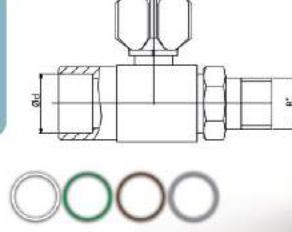

RADIATOR VALVE ELBOW
RADYATÖR VANASI DİRSEK
ВЕНТИЛЬ ДЛЯ РАДИАТОРА УГЛОВОЙ
سخان مستقيم بکوع

ITEM CODE Kod No	Ød Ød	R" R"	Pcs/pkg Adet/paket
190470200020	20	1/2	20
190470250025	25	3/4	25

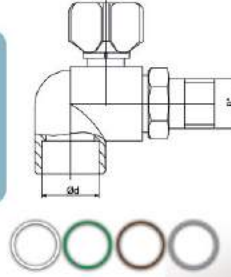

MALE FILTER
ERKEK FİLTRE
ФИЛЬТР ВНУТР. / НАРУЖ.
صمام ذکري لتصفية الماء

ITEM CODE Kod No	Ød Ød	L L	Pcs/pkg Adet/paket
19071020	20	76	50
19071025	25	88	30
19071032	32	106	25

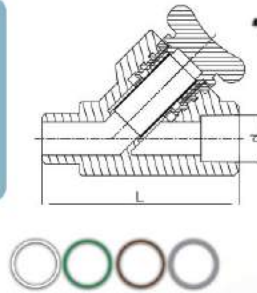

FEMALE FILTER
DIŞI FİLTRE
ФИЛЬТР ВНУТР. / ВНУТР.
صمام انثى لتصفية الماء

ITEM CODE Kod No	Ød Ød	L L	Pcs/pkg Adet/paket
19070020	20	76	50
19070025	25	88	30
19070032	32	106	25

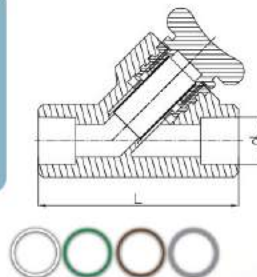

EGETHERM SANITARY PIPES AND FITTINGS

CLIPS
KLİPS
КРЕПЛЕНИЕ
مربط

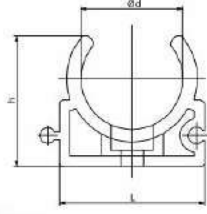

ITEM CODE Kod No	Ød Ød	L L	h h	PCS/BOX Adet/ Kutu
19016020	20	29	28	300
19016025	25	35	32	250
19016032	32	44	38	200

CLIPS
KLİPS
КРЕПЛЕНИЕ
مربط

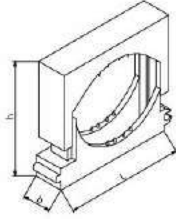

ITEM CODE Kod No	Ød Ød	L L	h h	b b	PCS/BOX Adet/ Kutu
190160400050	40	65	57	16	100
190160400050	50	65	67	16	100

*Note: This item can be adjusted for the diameter Ø40mm.
Not: Bu klips Ø40 çapa da ayarlanabilir.*

CLIPS
KLİPS
КРЕПЛЕНИЕ
مربط

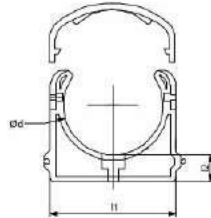

ITEM CODE Kod No	Ød Ød	l1 l1	l2 l2	PCS/BOX Adet/ Kutu
19016063	63	92	19	100

DOUBLE CLIPS
ÇİFTLİ KLİPS
КРЕПЛЕНИЕ ДВОЙНОЕ
مربط تنائي

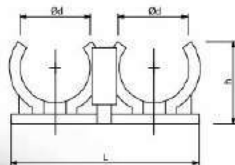

ITEM CODE Kod No	Ød Ød	L L	h h	PCS/BOX Adet/ Kutu
190160001020	20	53	23	300
190160001025	25			250

EGETHERM SANITARY PIPES AND FITTINGS

CROSS OVER
KÖPRÜ

ОБВОДНОЕ КОЛЕНО С МУФТОЙ

جسر

ITEM CODE Kod No	Ød Ød	L L	h h	PCS/BOX Adet/ Kutu
19017020 E	20	160	46	70
19017025 E	25	200	57	40
19017032 E	32	266	71	15

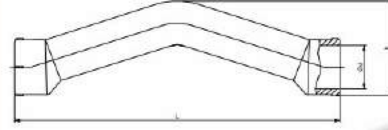

CROSS OVER
KÖPRÜ

ОБВОДНОЕ КОЛЕНО С МУФТОЙ

جسر

ITEM CODE Kod No	Ød Ød	L L	h h	PCS/BOX Adet/ Kutu
19017040	40	440	83	25

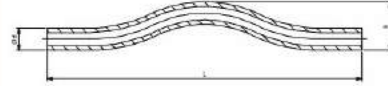

CROSS OVER SHORT
KÖPRÜ KISA

ОБВОДНОЕ КОЛЕНО С МУФТОЙ (КОРОТКОЕ)

جسر مع وطة

ITEM CODE Kod No	Ød Ød	L L	h h	PCS/BOX Adet/ Kutu
19017020KS	20	77	39	100
19017025KS	25	98	52	60
19017032KS	32			100

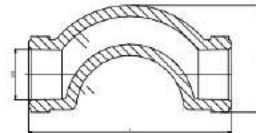

STOP VALVE
STOP VANA

ВЕНТИЛЬ

محبس

ITEM CODE Kod No	Ød Ød	L L	h h	PCS/BOX Adet/ Kutu
19040020	20	55	110	40
19040025	25	79	113	30
19040032	32	90	130	15

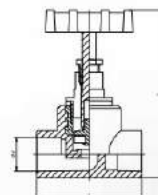

EGETHERM SANITARY PIPES AND FITTINGS

STOP VALVE WITH CHROME COVER (LUX)
LÜKS ANKASTRE VANA
ВЕНТИЛЬ ХРОМИРОМ. ЗАПОРНЫЙ EGETHERM ЛЮКС
محبس كروم لوکس

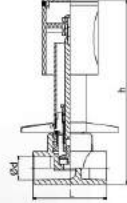

ITEM CODE Kod No	Ød Ød	L L	h h	PCS/BOX Adet/ Kutu
19044020	20	55	110	25
19044025	25	79	113	20
19044032	32	90	130	15

STOP VALVE WITH CHROME COVER
ANKASTRE VANA
ВЕНТИЛЬ ХРОМИРОМ. ЗАПОРНЫЙ
محبس كروم

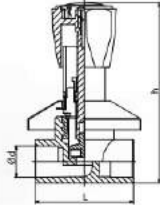

ITEM CODE Kod No	Ød Ød	L L	h h	PCS/BOX Adet/ Kutu
19042020	20	55	110	25
19042025	25	79	113	20
19042032	32	90	130	15

BALL COCK
SABİT GÖVDELİ KÜRESEL VANA
КРАН ШАРОВОЙ
محبس (كروي)

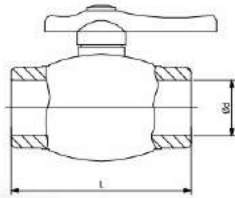

ITEM CODE Kod No	Ød Ød	L L	PCS/BOX Adet/ Kutu
19043020	20	74	40
19043025	25	83	30
19043032	32	90	20
19043040	40	112	10
19043050	50	118	8
19043063	63	140	4
19043075	75	166	4

UNION BALL COCK
KÜRESEL VANA (RAKORLU)
КРАН ШАРОВОЙ РАЗЪЕМНЫЙ
محبس (كروي)

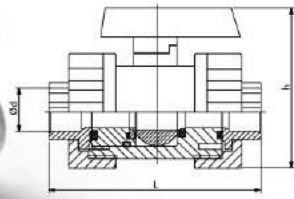

ITEM CODE Kod No	Ød Ød	L L	h h	PCS/BOX Adet/ Kutu
19041020	20	86	76	12
19041025	25	96	89	12
19041032	32	110	100	12
19041040	40	-	-	12
19041050	50	-	-	12
19041063	63	-	-	12
19041075	75	195	166	4
19041090	90	-	-	4

EGETHERM SANITARY PIPES AND FITTINGS

ITEM CODE Kod No	Ød Ød	L L	h h	PCS/BOX Adet/ Kutu
19045020	20	83	54	12
19045025	25	109	60	12
19045032	32	-	-	12
19045040	40	125	83	12
19045050	50	153	92	12
19045063	63	-	-	12
19045075	75	-	-	12
19045090	90	-	-	4
19045110	110	-	-	4

CHECK VALVE
ÇEK VALF
МУФТА РАЗЪЕМНАЯ ДВОЙНАЯ
صمام عمودي

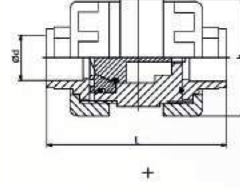

WELDING SADDLE
BRANŞMAN PARÇASI
МУФТА СЕДЛО ПРИВАРНОЕ
ركاب

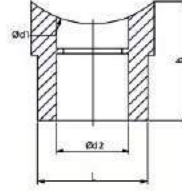

ITEM CODE Kod No	Ød1 Ød1	Ød2 Ød2	h h	PCS/BOX Adet/ Kutu
190330630020	63	20		250
190330630025	63	25		200
190330750020	70	20		150
190330750025	70	25		150



WELDING SOCKET
KAYNAK PAFTASI
НАСАДКА
(قطع لجام سفه)

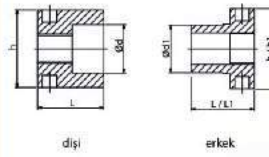

ITEM CODE Kod No	Ød Ød	Ød1 Ød1	L L	L1 L1	h h	h1 h1	PCS/BOX Adet/ Kutu
19302020	20	20	22	27	30	32	1
19302025	25	25	26	30	32	38	1
19302032	32	32	32	30	38	43	1
19302040	40	40	35	31	45	60	1
19302050	50	50	36	33	56	69	1
19302063	63	63	38	38	69	82	1
19302075	75	75	41	41	81	97	1
19302090	90	90					
19302110	110	110					

WELDING DEVICE
BRANŞMAN PAFTASI

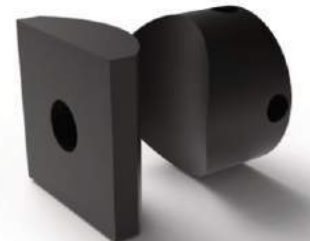
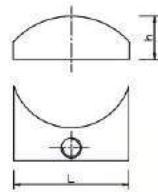

ITEM CODE Kod No	Ød Ød	L L	h h	PCS/BOX Adet/ Kutu
19310040	40	40	15	1
19310050	50	40	15	1
19310063	63	40	15	1
19310075	75	40	15	1

EGETHERM SANITARY PIPES AND FITTINGS

WELD IN SADDLE
KOMBİ SET
КОМПЛЕКТ ДЛЯ ПОДКЛЮЧЕНИЯ БОЙЛЕРА
طقم سخانات المياه



ITEM CODE

Kod No

19055S (8'li Set Adaptörlü)

190550ZEL25

Special (All 25 mm)



WELDING SET (Includings)
KAYNAK SETİ (2X650 W)
КОМПЛЕКТ ДЛЯ СВАРКИ ТРУБ 20-40 650W
طقم ماكينة لحام الأنابيب



ITEM CODE Kod No: 19060

PCS/BOX Adet Kutu: 1

Welding Machine (2 Resistance=650 W) Kaynak Makinesi
Pipe Cutter / Makas
Welding Socket / Kaynak Paftası (2 Pcs 20 mm Male &Female /2 Takım Erkek- Dişi)
Welding Socket / Kaynak Paftası (1 Pcs 25 mm Male &Female /1 Takım Erkek- Dişi)
Welding Socket / Kaynak Paftası (1 Pcs 32 mm Male &Female /1 Takım Erkek- Dişi)
Welding Socket / Kaynak Paftası (1 Pcs 40 mm Male &Female /1 Takım Erkek- Dişi)
Welding Socket Key (For Squeeze) / Kaynak Paftası Anahtarı
Bolt (4 Pcs for Welding Sockets) / Pafta için vida
Wrench (2 Pcs) / Anahtar
Measuring Stick/ Metre
Leg for Welding Machine/ Ayak
Metal Bag/ Metal Çanta
Guarantee Certificate / Garanti Belgesi
Pattern (for Welding Deepness signing) / Kaynak Boyu Şablonu

PIPE CUTTER
BORU MAKASI
РЕЗАК ДЛЯ ТРУБ
قاطع الأنابيب



ITEM CODE Kod No: 19062

PCS/BOX Adet Kutu: 1

EGETHERM SANITARY PIPES AND FITTINGS

PIPE REPAIR SOCKET (Male- Female)
BORU TAMİR PAFTASI (Erkek - Dişi)
РЕМОНТНЫЙ КОМПЛЕКТ
وصله إصلاح

ITEM CODE Kod No: 19064

PCS/BOX Adet Kutu: 1



PIPE REPAIR SOCKET (Male- Female)
BORU TAMİR PAFTASI (Erkek - Dişi)
СВАРОЧНЫЙ РАЗЪЕМ
وصله لحام

ITEM CODE Kod No: 19064

PCS/BOX Adet Kutu: 1



PEELING TOOL
FOLYOLU BORU TRAŞ MAKİNASI
ЗАЧИСТКА ДЛЯ ТРУБ
اداة تقشير / مبراة

ITEM CODE
Kod No

Ød
Ød

Pcs/pkg
Adet/kutu

195100200025	20/25	1
195100320040	32/40	1
195100400050	32/40	1
195100500063	50/63	1
195100630075	63/75	1



PP STICK FOR REPAIRING PIPE
PP TAMİR KAYNAK ÇUBUĞU
РЕМОНТНЫЙ КОМПЛЕКТ
قطعة لحام PPR

ITEM CODE Kod No: 19002010

PCS/BOX Adet Kutu: 1



ITEM CODE Kod No: 19002010

PCS/BOX Adet Kutu: 1

RESISTANCE
REZİSTANS
РЕЗИСТАНС
مقاوم



**PVC-U
RAIN GUTTER
& DOWN PIPES**

**PVC-U ÇATI OLUĞU
VE YAĞMUR İNİŞ
BORULARI**



TS EN ISO 9001:2000



PVC RAIN GUTTER AND DOWN PIPES

100 RAIN GUTTER

100 ÇATI OLUĞU

100мм желоб

انابيب زخلية مياه الأمطار



ITEM CODE Kod No	Ød(mm) Ød(mm)	h(mm) h(mm)	l(mm) lMetre	Pcs/Pkg Adet/ Paket
120011004000	104	78,5	4	5

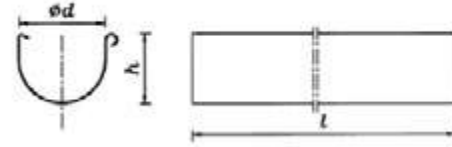

RAIN GUTTER SLEEVE

ÇATI OLUĞU MANŞON

Муфта для желоба

وصلة



ITEM CODE Kod No	Ød(mm) Ød(mm)	h(mm) h(mm)	l(mm) lMetre	Pcs/Pkg Adet/ Paket
12015100	104	79	112	50

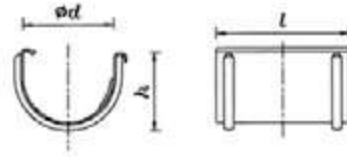

100 RAIN GUTTER INNER BELOW

100 ÇATI OLUĞU İÇ DİRSEK

100мм угловой элемент внутренний

كوع



ITEM CODE Kod No	Ød(mm) Ød(mm)	h(mm) h(mm)	Pcs/Pkg Adet/ Paket
12159100	104	184	25

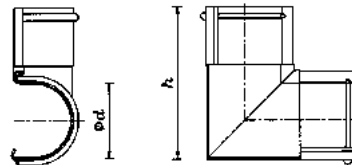

100 RAIN GUTTER OUTER BELOW

100 ÇATI OLUĞU DIŞ DİRSEK

100мм угловой элемент наружный

كوع



ITEM CODE Kod No	Ød(mm) Ød(mm)	h(mm) h(mm)	Pcs/Pkg Adet/ Paket
12158100	104	184	25

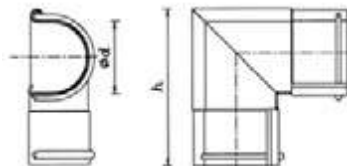

PVC RAIN GUTTER AND DOWN PIPES

100/70 RAIN GUTTER TE
100/70 MANŞET TE
100x70mm воронка
70/100 تي



ITEM CODE	Ød(mm)	Ød1(mm)	h(mm)	h1(mm)	l(mm)	Pcs/Pkg
Kod No	Ød(mm)	Ød1(mm)	h(mm)	h1(mm)	l(mm)	Pcs/Pkg
120291000070	104	75	132	51	200	40

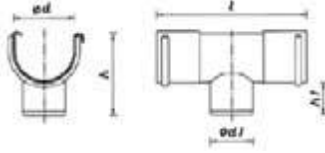

100 RAIN GUTTER ENDPLUG
100 ÇATI OLUĞU KÖR TAPA
100mm Заглушка желоба
100 سدّة



ITEM CODE	Ød(mm)	l(mm)	Pcs/Pkg
Kod No	Ød(mm)	l(mm)	Adet/ Paket
12014100	104	4	300

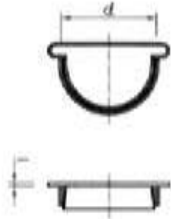

Ø 75 DOWN PIPE
Ø 75 İNİŞ BORUSU
75mm водосточная труба
أنايب تدفق مياه الأمطار



ITEM CODE	Ød(mm)	l(mm)	Pcs/Pkg
Kod No	Ød(mm)	l(mm)	Pcs/Pkg
055010700150	75	150	60
055010700250	75	250	35
055010700500	75	500	20
055010700750	75	750	20
055010701000	75	1000	20
055010702000	75	2000	1
055010703000	75	3000	1
055010706000	75	6000	1

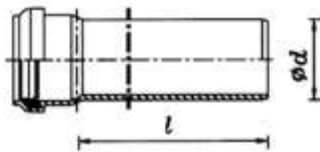

PVC RAIN GUTTER AND DOWN PIPES

100 RAIN GUTTER BRACELETTE
100 ÇATI OLUĞU KELEPÇESİ
100мм металлическая клипса
100 مربوط



ITEM CODE Kod No	Ød(mm) Ød(mm)	h(mm) h(mm)	l(mm) lMetre	Pcs/Pkg Adet/ Paket
12039100	104	25	175	50

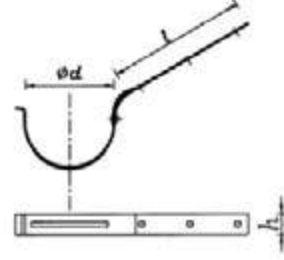

Ø 75 DOWN PIPE BRACELETTE
Ø 75 İNİŞ BORUSU KELEPÇESİ
75мм крепление трубы
75 مربوط



ITEM CODE Kod No	Ød(mm) Ød(mm)	l1(mm) l1(mm)	l2(mm) l2Metre	Pcs/Pkg Adet/ Paket
04039070	75	95	20	100

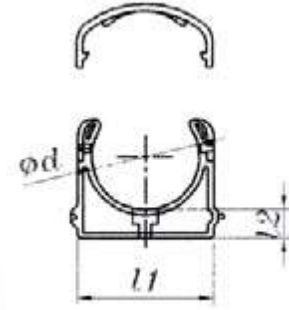

150 RECTANGULAR RAIN GUTTER
150 KÖŞELİ YAĞMUR DERESİ
150мм прямоугольный желоб
نظية مياه الأمطار 150 انبوب مستطيل

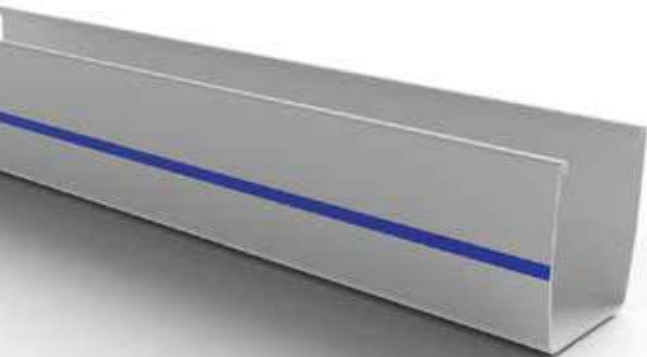

ITEM CODE Kod No	a(mm) a(mm)	h(mm) h(mm)	l(mm) l(mm)	Pcs/Pkg Adet/ Paket
120011504000	112	117,5	4	5

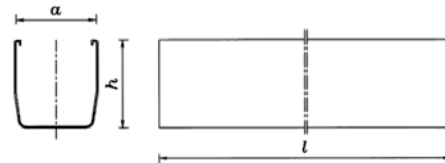

PVC RAIN GUTTER AND DOWN PIPES

150 RECTANGULAR RAIN GUTTER SLEEVE

150 KÖŞELİ YAĞMUR DERESİ MANŞON

150mm прямоугольная муфта для желоба

وطة مستطيلة

ITEM CODE Kod No	a(mm) a(mm)	h(mm) h(mm)	l(mm) l(mm)	Pcs/Pkg Adet/ Paket
12015150	113	134	133	50

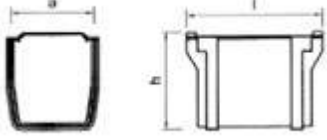

150 RECTANGULAR RAIN GUTTER ELBOW

150 KÖŞELİ YAĞMUR DERESİ DİRSEK

150mm угловой элемент прямоугольный

كوع مستطيل 150

ITEM CODE Kod No	a(mm) a(mm)	h(mm) h(mm)	l(mm) l(mm)	Pcs/Pkg Adet/ Paket
12038150	112	117,5	178	32

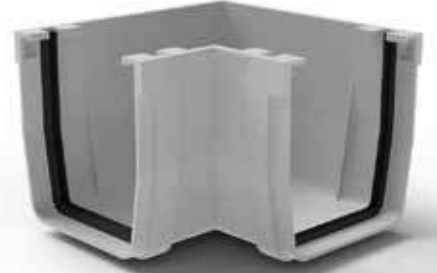
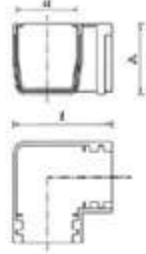

150/100 RECTANGULAR RAIN GUTTER TEE

150 /100 KÖŞELİ YAĞMUR DERESİ MANŞET TE

150x100mm прямоугольная воронка

تي مستطيلة 100/150

ITEM CODE Kod No	a(mm) a(mm)	bxc(mm) bxc(mm)	h(mm) hmm	h1(mm) h1(mm)	l(mm) l(mm)	Pcs/Pkg Adet/ Paket
120291500100	112	97x67	125	54	250	18

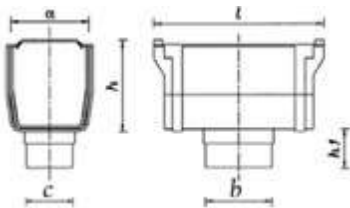

PVC RAIN GUTTER AND DOWN PIPES

150/70 RECTANGULAR RAIN GUTTER TEE
150 /70 KÖŞELİ YAĞMUR DERESİ MANŞET TE (YUVARLAK)
150/70 мм прямоугольная воронка (круглый выход)
150/70 تبي مستطيلة



ITEM CODE	a(mm)	Ød1(mm)	h(mm)	h1(mm)	l(mm)	Pcs/Pkg
Kod No	a(mm)	Ød1(mm)	h(mm)	h1(mm)	l(mm)	Adet/ Paket
12091500070	112	75	125	57	250	18

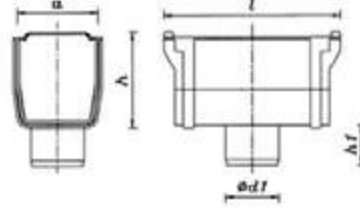

150 RECTANGULAR RAIN GUTTER ENDPLUG
150 KÖŞELİ YAĞMUR DERESİ KÖRTAPA
150мм прямоугольная заглушка желоба
سدة مستطيلة



ITEM CODE	a(mm)	h(mm)	l(mm)	Pcs/Pkg
Kod No	a(mm)	h(mm)	l(mm)	Adet/ Paket
12014150	112	123	7	100



150 RAIN GUTTER BRACELETTE
150 KÖŞELİ YAĞMUR DERESİ KELEPÇESİ
150мм металлическая клипса
150 مبرط



ITEM CODE	a(mm)	h(mm)	l(mm)	Pcs/Pkg
Kod No	a(mm)	h(mm)	l(mm)	Adet/ Paket
12039150	124	33	255	50

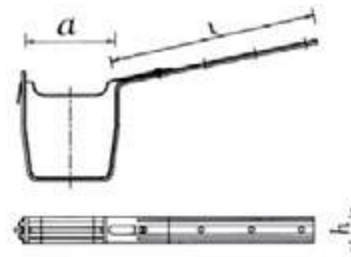

PVC RAIN GUTTER AND DOWN PIPES

100/70 RECTANGULAR DOWN PIPE

100/70 KÖŞELİ İNİŞ BORUSU

100/70 mm водосточная труба

أنبوب لتدفق مياه الأمطار مستطيل

ITEM CODE Kod No	∅d(mm) ∅d(mm)	l(mm) l(mm)	Pcs/Pkg Pcs/Pkg
---------------------	------------------	----------------	--------------------

130011500500U	97,5x67,5	500	4
130011501000U	97,5x67,5	1000	4
130011502000U	97,5x67,5	2000	4
130011503000U	97,5x67,5	3000	4
130011504000U	97,5x67,5	4000	4
130011505000U	97,5x67,5	5000	4
130011506000U	97,5x67,5	6000	4

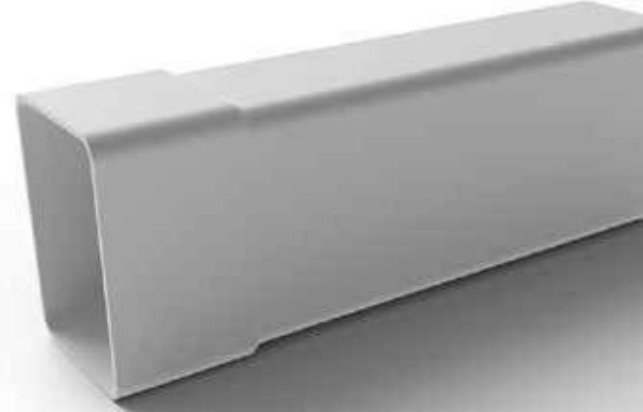
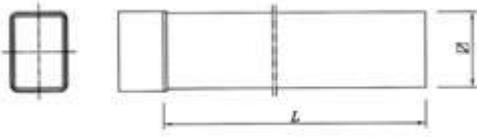

RECTANGULAR DOWN PIPE SLEEVE

KÖŞELİ İNİŞ BORUSU MANŞONU

Муфта прямоугольный для желоба

وصلة لأنبوب تدفق مياه الأمطار مستطيل

ITEM CODE Kod No	∅(mm) ∅(mm)	h(mm) h(mm)	Bundle Bağ
---------------------	----------------	----------------	---------------

13015150	97,5x67,5	41	100
----------	-----------	----	-----

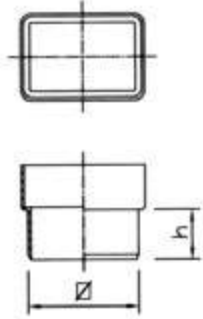

RECTANGULAR DOWN PIPE ELBOW 45°

KÖŞELİ İNİŞ BORUSU DİRSEĞİ 45°

Прямоугольный угольник 45°

كوع لأنبوب تدفق مياه الأمطار مستطيل

ITEM CODE Kod No	∅(mm) ∅(mm)	Pcs/Pkg Bağ
---------------------	----------------	----------------

13038150	97,5x67,5	50
----------	-----------	----

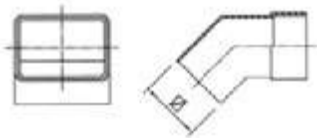

PVC RAIN GUTTER AND DOWN PIPES

RECTANGULAR DOWN PIPE SINGLE BRANCH 45°

KÖŞELİ İNİŞ BORUSU TEK ÇATAL 45°

прямоугольная труба с отводом

كوع مغرد 45°



ITEM CODE	∅(mm)	Ød1(mm)	L(mm)	Pcs/Pkg
Kod No	∅(mm)	Ød1(mm)	L(mm)	Adet/ Paket
13030150	97,5X67,5	50	133	25

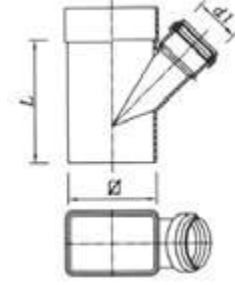

RECTANGULAR DOWN PIPE DOUBLE BRANCH 45°

KÖŞELİ İNİŞ BORUSU ÇİFT ÇATAL 45°

прямоугольная труба с двумя отводами

تفريع مزدوج 45°



ITEM CODE	∅(mm)	Ød1(mm)	L(mm)	Pcs/Pkg
Kod No	∅(mm)	Ød1(mm)	L(mm)	Adet/ Paket
13020150	97,5X67,5	50	133	25

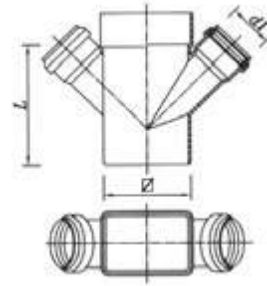

RECTANGULAR DOWN PIPE BRACELETTE

KÖŞELİ İNİŞ BORU KELEPÇESİ

Крепление для прямоугольной трубы

مربط



ITEM CODE	a(mm)	b(mm)	Pcs/Pkg
Kod No	a(mm)	b(mm)	Adet/ Paket
13039150	137,5	85	80

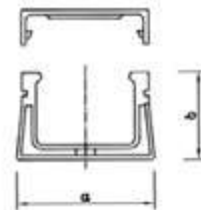

HEATING SYSTEMS PIPES AND FITTINGS

ISITMA SİSTEMLERİ BORU VE EK PARÇALARI

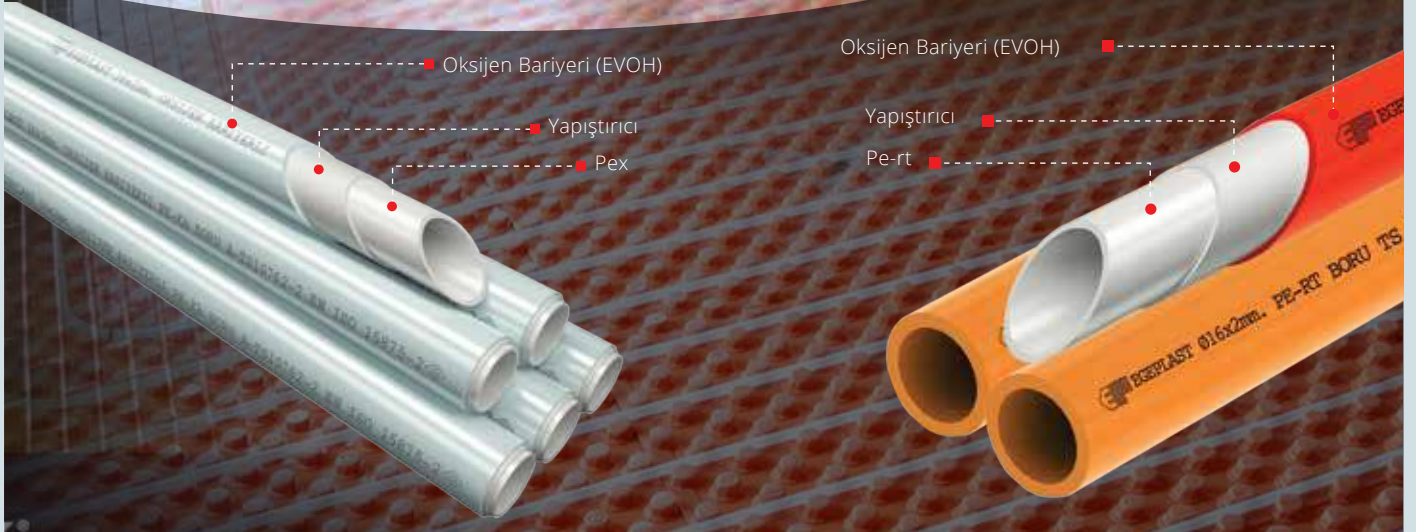

TS EN ISO 9001:2000



HEATING SYSTEMS PIPES AND FITTINGS

The pipes, which are used in the heating systems, should be resistant to high temperatures. Cross-linked Polyethylene with high temperature resistance and usage easiness has been unique product for heating systems.

Main raw material is Polyethylene. The cross - links are created with chemical and/or physical methods in the material. These links bring the resistance to high temperatures. The number of the fittings used in installation can be very little because of the flexibility of the pipes. This results in more economical and faster installation.

ISITMA SİSTEMLERİ BORU VE EK PARÇALARI

Radyatör ve zemin ısıtma sistemlerinde kullanılan boruların yüksek sıcaklıklara direnç göstermesi gerekir. Çapraz bağlı Polietilen-PEX (Crosslinked Polyethylene) yüksek sıcaklıklara mukavemeti ve aynı anda sağladığı kullanım kolaylığı ile bu sistemlerde rakipsiz bir ürün olmuştur.

Ana hammadde polietilendir. Bu malzeme içinde kimyasal ya da fiziksel yöntemlerle çapraz bağlar oluşturulur. Bu bağlar malzemenin yüksek sıcaklığa mukavemetini sağlar, boruların esnekliği ek parça kullanımını asgariye indirir, montajda hız ve ekonomi sağlar. TS EN ISO 15875-2 'ye uygundur.



PEX PIPE WITH OXYGEN BARRIER OKSİJEN BARİYERLİ PEX BORU

ITEM Kod No	Outside Diameter Boru Çapı(mm)	Wall thickness Et Kalınlığı (mm)	Lenght of coil (m) Kangal Boyu (m)
160100160020	Ø16	2.0	100

PEX PIPE WITH OXYGEN BARRIER (WITH COVER) OKSİJEN BARİYERLİ PEX BORU (KILIFLI)

ITEM Kod No	Outside Diameter Boru Çapı(mm)	Wall thickness Et Kalınlığı (mm)	Lenght of coil (m) Kangal Boyu (m)
16006016 K	Ø16	2.0	100
16006016 M	Ø16	2.0	100

PEX PIPE WITH OXYGEN BARRIER

EGEPLAST produces "PEX Pipe with Barrier" (with EVOH oxygen barrier layer) for a large number of radiant heating applications such as radiant floor heating, radiator systems and for boiler supply.

What is the Purposes and Advantages of PEX Plumbing?

Due to their characteristics, plastic pipes may allow oxygen penetrate into the heating systems. In this case, being exposed to oxygen, the metallic components may corrode over time as these systems include some ferrous (iron-containing) components, to prevent this, a layer of a special polymer, abbreviated EVOH is applied to the external surface of the PEX pipe during the manufacturing process, in order to protect the PEX pipes. As this application prevents the diffusion of oxygen molecules into the system, corrossions are significantly minimized in the installings.

External Layer: EVOH Copolymer layer with perfect oxygen-barrier features.

Mid-layer: The mid-layer which bonds the internal pex pipe with the external oxygen barrier layer.

Internal Layer: Hygienic cross-linked pex pipe with high physical and chemical resistance features.

OKSİJEN BARIYERLİ PEX BORU

EGEPLAST A.Ş. Mobil Kalorifer, Kombi Tesisatı ve Yerden Isıtma Sistemlerinde kullanılmak amacı ile Oksijen Bariyerli PEX boruyu da üretetek kullanıma sunmaktadır.

Oksijen bariyeri ne demektir, bu borunun faydası nedir?

Plastik malzemelerin oksijen geçirgenlik özelliklerinden dolayı, ısıtma sistemlerinde suya dışarıdan oksijen girmesi mümkündür, böyle durumlarda zamanla radyatör, kombi, kazan ve tesisatta oksitlenme ve paslanmalar meydana gelir.

Bunu önlemek için pex boruların dış yüzeyleri üretim aşamasında özel bir yöntemle oksijen geçirmezlik özelliği olan parlak EVOH malzeme ile kaplanarak oksijen bariyerli hale getirilir. Böylece tesisattaki suya oksijen geçişi engellenerek, tesisatta paslanma ve oksitlenme görülmez.

Dış Katman: Mükemmel oksijen bariyeri özelliklerine sahip evoh kopolimer katman.

Orta Katman: Oksijen bariyer katmanı ile içteki pex borunun birbirine yapışmasını sağlayan yapıştırıcı katman

İç Katman: Hijyenik, yüksek fiziksel ve kimyasal dayanım özelliklerine sahip çapraz bağlı pex boru.

TEKNİK ÖZELLİKLER

Dış Çap: 16mm

Et Kalınlığı: 2mm

Yoğunluk: 0.950 g/cm³

Çapraz Bağlanma Şekli: PEX-B

Çapraz Bağlanma Oranı: En az %65

Çalışma Sıcaklığı: -40 °C +95 °C

Lineer Genleşme Katsayısı: 2x10⁻⁵ 1/K

Isı İletkenliği: 0.41 W/MK

Özgül Isı 23 °C'de: 1.9 J/G K

E-Modülü: 600 N/MM²

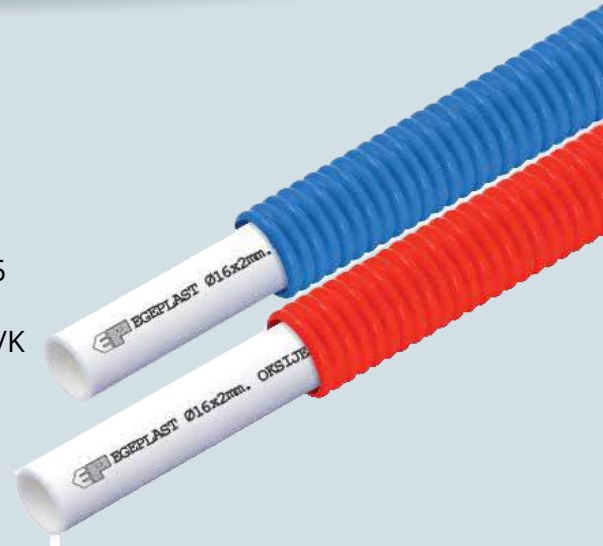

HEATING SYSTEMS PIPES AND FITTINGS

ITEM CODE Kod No	Outside Diameter Boru Çapı(mm)	Wall Thickness Et Kalınlığı(mm)	Length of Coil(m) Kangal Boyu
16002016	Ø16	1.8	200
160020160020	Ø16	2.0	160
16002017	Ø17*	1.9	100
16002020	Ø20	1.9	100

*The pipes in 17 mm outside diameter are out of standard.
* 17 mm dış çaplı borularımız dış çap yönünden standart kapsamı dışındadır.

PEX-B PIPES
PEX-B BORULARI
PEX-b трубы
أنبوب بكس



PEX PIPES WITH OXYGEN BARRIER
OKSİJEN BARIYERLİ PEX BORU
PEX трубы с Кислородным Барьером
أنابيب مانعة للأوكسجين

ITEM CODE Kod No	Outside Diameter Boru Çapı(mm)	Wall Thickness Et Kalınlığı(mm)	Length of Coil(m) Kangal Boyu
160100160020	Ø16	2.0	100



PEX-B PIPES WITH SPIRAL COVER
KILIFLI PEX-B BORULAR
PEX-b трубы с защитной гафрированной трубой
غلاف أنابيب البيكس

ITEM CODE Kod No	Outside Diameter Boru Çapı(mm)	Wall Thickness Et Kalınlığı(mm)	Length of Coil(m) Kangal Boyu
16005016 M	Ø16	1.8	100
16005016 K	Ø16	1.8	100



ITEM CODE Kod No	Ød1 Ød1	Ød2 Ød2	Color Renk
*24001025M	19	24	Blue (Mavi)
*24001025K	19	24	Red (Kırmızı)
**24001032M	21.5	26	Blue (Mavi)
**24001032K	21.5	26	Red (Kırmızı)

* Outside diameter for 16 and 17 mm Pex pipes
** Outside diameter for 20 mm Pex pipes
* Dış çap 16 ve 17 mm borular için
* * Dış çap 20 mm borular için

SPIRAL COVERS FOR PEX PIPES
PEX BORU KILIFLARI
Защитные гафрированные трубы
أنبوب بكس



PEX PIPES WITH OXYGEN BARRIER AND SPIRAL COVER
KILIFLI OKSİJEN BARIYERLİ PEX BORULARI
PEX трубы с Кислородным Барьером и с защитной гафрированной трубой
غلاف أنابيب البيكس

ITEM CODE Kod No	Outside Diameter Boru Çapı(mm)	Wall Thickness Et Kalınlığı(mm)	Length of Coil(m) Kangal Boyu
16006016 K	Ø16		100
16006016 M	Ø16		100



PE-RT BORU VE EK PARÇALARI

PE-RT (Polyethylene of raised temperature resistance) Türkçe tanımı, Sıcaklık Direnci Yükseltilmiş Polietilen'dir. Tip 1 ve Tip 2 olmak üzere 2 tip PE-RT hammaddesi vardır. Firmamız Tip 2 kodlu hammaddeden üretim yapmaktadır. Tip 2 hammaddenin Tip 1'e göre sıcaklık -basınç dayanımı daha yüksektir. PEX borunun kullanıldığı Mobil Kalorifer, Kombi ve yerden ısıtma sistemlerinde kullanılabilir.

Dış çap 16 x 2 mm kalınlığında PE-RT boru ve Oksijen Bariyerli PE-RT boru olarak üretimi mevcuttur. oksijen bariyeri, PE-RT borunun dış yüzeyi, üretim aşamasında özel yapıştırıcı ile Oksijen Geçirmezlik olan EVOH malzeme ile kaplanarak sağlanmaktadır. Bu borunun kullanımı ile, ısıtma sistemlerinde suya dışarıdan oksijen geçişi engelleyerek, radyatör, kombi, kazan ve tesisatta olası oksitlenme ve paslanmanın önüne geçilmiş olmaktadır.

TS EN ISO 22391-2 standardına uygundur.

Renk; PE-RT boru Turuncu, Oksijen Bariyerli PE-RT boru ise iç katmanı şeffaf dış katman kırmızı renktedir. Birleştirmede PEX boru uygulamasındaki prinç ek parçalar kullanılabilir. Kırmızı ve Mavi renkli spiral kılıflı 100 metre kangal olarak üretilmektedir.

Operating Temperature Çalışma Sıcaklığı (°C)	Service Life İşletme Ömrü (year/yıl)	Operating Pressure Çalışma Basıncı (PN)
70	50	8 Bar
40 - 60 °C Radyatörlerde	50	10 Bar
60 - 80 °C Radyatörlerde	50	8 Bar



Oksijen Bariyeri (EVOH)

Yapıştırıcı

Pe-rt

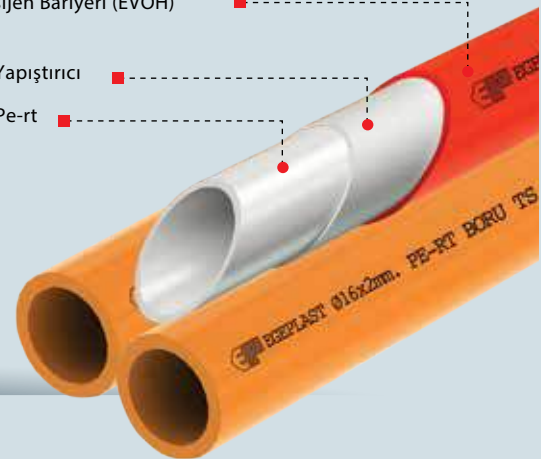

HEATING SYSTEMS PIPES AND FITTINGS

ITEM CODE Kod No	Outside Diameter Boru Çapı(mm)	Wall Thickness Et Kalınlığı(mm)	Length of Coil(m) Kangal Boyu
160200160020	Ø16	2.0	100
16020016002016		2.0	160

PE-RT PIPES
PE-RT BORU
PE-RT трубы



PE-RT PIPES WITH OXYGEN BARRIER
OKSİJEN BARIYERLİ PE-RT BORU

ITEM CODE Kod No	Outside Diameter Boru Çapı(mm)	Wall Thickness Et Kalınlığı(mm)	Length of Coil(m) Kangal Boyu
160300160020	Ø16	2.0	100
16030016002016	Ø16	2.0	160



PE-RT PIPES WITH SPIRAL COVER
KILIFLI PE-RT BORU

ITEM CODE Kod No	Outside Diameter Boru Çapı(mm)	Wall Thickness Et Kalınlığı(mm)	Length of Coil(m) Kangal Boyu
160250160020K	Ø16	2.0	100
160250160020M	Ø16	2.0	100



PE-RT PIPES WITH SPIRAL COVER
KILIFLI PE-RT BORU

ITEM CODE Kod No	Outside Diameter Boru Çapı(mm)	Wall Thickness Et Kalınlığı(mm)	Length of Coil(m) Kangal Boyu
160250160020K	Ø16	2.0	100
160250160020M	Ø16	2.0	100



PEX PIPES WITH OXYGEN BARRIER AND SPIRAL COVER
KILIFLI OKSİJEN BARIYERLİ PE-RT BORU

ITEM CODE Kod No	Outside Diameter Boru Çapı(mm)	Wall Thickness Et Kalınlığı(mm)	Length of Coil(m) Kangal Boyu
160350160020K	Ø16	2.0	100
160350160020M	Ø16	2.0	100



HEATING SYSTEMS PIPES AND FITTINGS

MINI BALL VALVE
EGE MİNİ KÜRESEL VANA
Кран шаровый мини
صمام مدور للبكس



ITEM CODE Kod No	Ød1(mm) Ød1(mm)	Øa(mm) Øa(mm)	Øb(mm) Øb(mm)
16169002	Ø16	12	16.5
16169001	Ø17	13	17.5

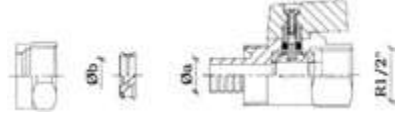

MANIFOLD AIRVENT
PURJÖR
Кран сброса воздуха из коллектора
أكرة تنغيس الماء

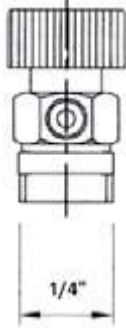

ITEM CODE / Kod No 16172001

STRAIGHT NIPPLE DOUBLE
BORU BİRLEŞTİRME RAKORU
Соединение промежуточное
أكرة تنغيس الماء



ITEM CODE Kod No	Outside Diameter (mm) Boru Çapı (mm)	Øa (mm) Øa(mm)	Øb (mm) Øb(mm)
16220016	Ø16	12	16.2
16220017	Ø17	13	17.2
16220020	Ø20	16	20.2



HEATING SYSTEMS PIPES AND FITTINGS

ITEM CODE Kod No	Outside Diameter (mm) Boru Çapı (mm)	Øa (mm) Øa(mm)	Øb (mm) Øb(mm)
16210016	Ø16	12	16.2
16210017	Ø17	13	17.2
16210020	Ø20	16	20.2

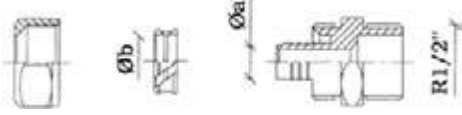

STRAIGHT NIPPLE MALE
EGE RADYATÖR BAĞLANTI NİPELİ
Соединение промежуточное
أكرة بسن مذکر



ITEM CODE Kod No	Outside Diameter (mm) Boru Çapı (mm)	L(mm) L(mm)
16200056	Ø15x1	565



BRASS PIPE
PİRİNÇ BORU
Латунная труба
انبوب نحاس



ITEM CODE Kod No	Number of Outlet Çıkış Adedi	a(mm) a(mm)
161650170002	2	95
161650170003	3	140
161650170004	4	185
161650170005	5	230
161650170006	6	270
161650170007	7	320
161650170008	8	365
161650170009	9	410
161650170010	10	455
161650170011	11	500
161650170012	12	545

Note: It can be manufactured with more than 12 outlets upon request.
Not: 12'den daha fazla çıkışlı da üretilebilir.

MANIFOLD
PİRİNÇ KOLLEKTÖR
Латунный коллектор
صفاة الماء

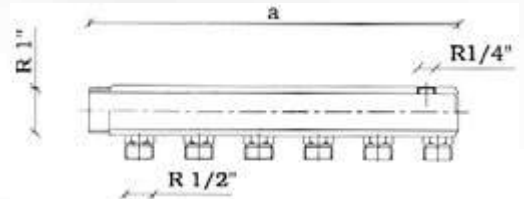

HEATING SYSTEMS PIPES AND FITTINGS

FLOOR HEATING PIPE FIXING RAIL AND CLIPS

EGE ZEMİN ISITMA LAMA VE KLİPSİ

Монтажная пластина и фиксаторы

مربط انابيب ارضي



FIXING RAIL / Lama Code Kod / No 16168

CLIPS / Klips Code Kod / No 16164017

ANGLE PIPE GUIDE

EGE KÖŞE DÖNDÜRÜCÜ AYAK

Угловая направляющая трубы

زاوية انبوب

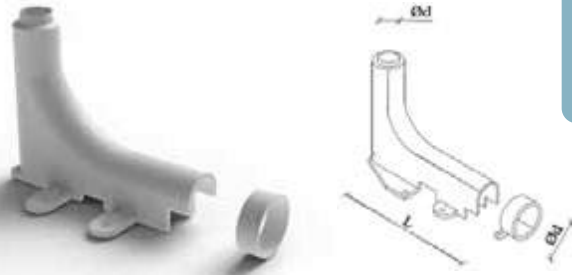

ITEM CODE Ød(mm) L(mm)
Kod No Ød(mm) L(mm)

16170 Ø17.5 124

TRANSPARENT SEAL

BORU ŞAPKASI

Колпак для PEX трубы

سدة شفافة

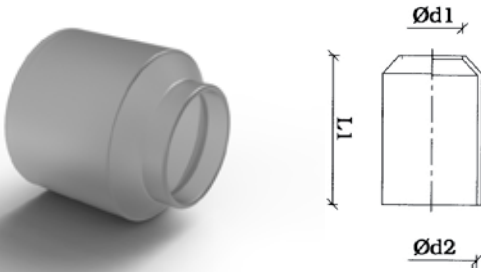

ITEM CODE Ød1(mm) Ød2(mm) L1(mm)
Kod No Ød1(mm) Ød2(mm) L1(mm)

16236016 16.5 26 28

16236017 17.5 26 28

MANIFOLD BRACKET

EGE KOLLEKTÖR KELEPÇESİ

Клипса для коллектора

مربط معدني

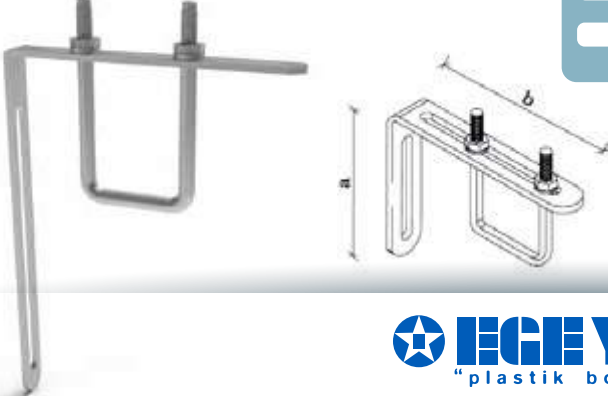

ITEM CODE a(mm) b(mm)
Kod No a(mm) b(mm)

16230002 120 93.5

16230001 176 87.5

HEATING SYSTEMS PIPES AND FITTINGS

ITEM CODE Kod No	Ød(mm) Ød(mm)
16235001	Ø16-17

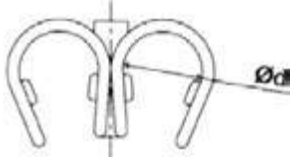

DOUBLE CLIPS
EGE KILIF İÇ TUTUCU (Çiftli)
фиксатор двойной
مربط ثنائي



ITEM CODE / Kod No	16240001
--------------------	----------

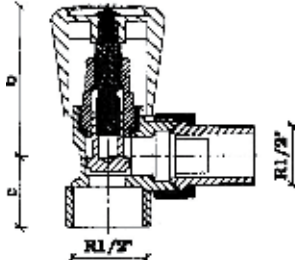

ANGLE VALVE
KÖŞE RADYATÖR VANASI
Радиаторный вентиль прямой
صمام مستقيم



ITEM CODE / Kod No	16245001
--------------------	----------

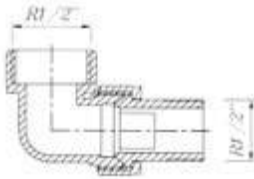

ANGLE FITTING FOR RADIATOR
KÖŞE RADYATÖR RAKORU
Муфта для радиатора угловая
ملحق زاوية للسخان



ITEM CODE Kod No	Outside Diameter (mm) Boru Çapı (mm)	Øa (mm) Øa(mm)	Øb (mm) Øb(mm)
16169016	Ø16	12	16.2
16169017	Ø17	13	17.2
16169020	Ø20	16	20.2

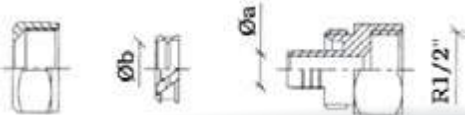

STRAIGHT NIPPLE FEMALE
EGE RADYATÖR BAĞLANTI NİPELİ
Муфта соединительная для коллектора
أكرة بسن مؤنث



HEATING SYSTEMS PIPES AND FITTINGS

BRASS PIPE SOTTOM CONNECTION EGE PİRİNÇ BORU ALT BAĞLANTISI

Соединительные элементы для латунной трубы

وطله نحاسي



ITEM CODE	Outside Diameter(mm)	Øa(mm)	Øb(mm)	Øc(mm)
Kod No	Boru Çapı (mm)	Øa(mm)	Øb(mm)	Øc(mm)
16225016	Ø16	12	16.2	15
16225017	Ø17	13	17.2	15
16225020	Ø20	16	20.2	15



ROSETTE PIPE ROZET BORUSU

Особая труба для соединения рех труб

انبوب روزيت



ITEM CODE	Ød1(mm)	L1(mm)
Kod No	Ød1(mm)	L1(mm)
16250002 Rosette Pipe	24	150



ROSETTE ROZET Розет

روزيت



ITEM CODE	Kod No	16250001 Rosette

1" BALL VALVE WITH HANDLE 1" KOLLEKTÖR KÜRESEL VANA

кран шаровый для коллектора

صمام مدور لتجميع الماء



ITEM CODE	Kod No	16237001

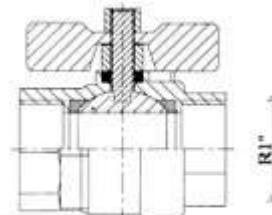

HEATING SYSTEMS PIPES AND FITTINGS

STRAIGHT FITTING
DÜZ RADYATÖR RAKORU
Муфта для радиатора прямая
صمام مستقيم

ITEM CODE / Kod No 16245002

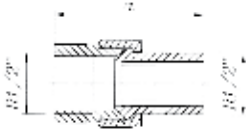

ANGLE LOCKSHIELD VALVE
GERİ DÖNÜŞ VANASI
Запорный клапан угловой
زاوية صمام

ITEM CODE / Kod No 16240003

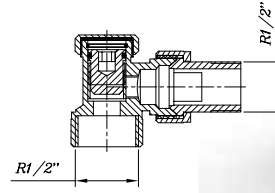

METAL U PIECE
U PARÇASI
Металлическая деталь U
قطعة معدنية U

ITEM CODE Kod No	a(mm) a(mm)	L1(mm) L1(mm)
16180002	41	70



METAL Z PIECE
Z PARÇASI
Металлическая деталь Z
قطعة معدنية Z

ITEM CODE Kod No	a(mm) a(mm)	L1(mm) L1(mm)
16180001	41	57

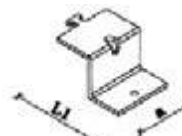

STRAIGHT VALVE
DÜZ RADYATÖR VANASI
Радиаторный вентиль угловой
زاوية صمام للسخان

ITEM CODE / Kod No 16240002

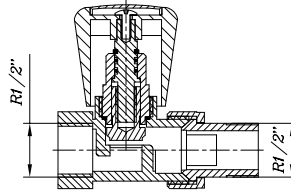

COLLECTOR CASE
KOLLEKTÖR DOLABI
Шкаф для коллектора
آلة التجميع

ITEM CODE Kod No	a(mm) a(mm)	b(mm) b(mm)	h(mm) h(mm)
---------------------	----------------	----------------	----------------

16171001 (Small (5-8) küçük)	300	130	650
16171003 (Middle) orta	450	130	650
16171002 (Big 9-12) büyük	600	130	650



Kalite Belgelerimiz



PPRC HİJYEN

PE HİJYEN RUSYA BELARUS KAZAKİSTAN

PVC TEMİZ SU HİJYEN

TS EN 12201-2+A1 / PE100 BORU

TS EN 13476-3+A1 / KORUGE BORU

TS EN ISO 1452-2 / PVC-U TEMİZ SU BORULAR

TS 10762-2 EN ISO 15875-2 / PEX B BORULAR

TS EN 1401-1 / PVC-U KANALİZASYON BORULARI

TS 9128 / PVC-U DRENAJ BORULARI

TS 13715 / EGEKOMPOZİT BORULAR

TS EN 607 / PVC-U YAĞMUR OLUĞU VE EK PARÇALARI

TS EN ISO 15874-3 / EGETHERM EK PARÇALARI

TS EN 1329-1 / PVC-U PİSSU BORU VE EKLEME PARÇALAR

TS EN ISO 15874-2 / EGETHERM BORULARI

TS EN 1452-3 / PVC-U TEMİZ SU EK PARÇA

TS EN ISO 9261 / DAMLAMA BORULARI

TS EN 12201-3 +A1 / PE 100 EK PARÇALAR(ALIN KAYNAKLI)

TS EN 1555-2 / PE 80 DOĞALGAZ BORULARI

PPRC TEMİZ SU HİJYEN TS EN ISO 1451-1 / PP PİS BORU VE EKLEME PARÇALARI





ECEPLAST
"quality at plastic pipe"

İZMİR FACTORY & HEAD OFFICE

10003 Sok. No:6 Atatürk Organize Sanayi Bölgesi Çiğli - İZMİR
T. +90 (232) 376 66 31
F. +90 (232) 376 81 43

İSTANBUL KOZYATAĞI BRANCH OFFICE

Kozyatağı Bayar Cad. Gülbahar Sok. No:15
Ege Yıldız Sitesi Kadıköy - İSTANBUL
T. +90 (216) 362 97 27
F. +90 (216) 373 88 32

İSTANBUL RAMİ BRANCH OFFICE

Kışla Cad. Sanayi Sok. No:16 Bayrampaşa - İSTANBUL
T. +90 (212) 563 95 80 - 89
F. +90 (212) 563 95 85

ANKARA BRANCH OFFICE

Rüzgarlı Ege Sok. Ege Yıldız İşhanı Ulus - ANKARA
T. +90 (312) 310 31 85
F. +90 (312) 310 01 84

ANTALYA BRANCH OFFICE

Meydan Kavşağı Mahallesi Perge Bulvarı Taha Berk Apt. K:1 D:4 - ANTALYA
T. +90 (242) 321 39 90
F. +90 (242) 321 39 92

ADANA BRANCH OFFICE

Ceyhan yolu üzeri 2. km EBK Karşısı Yüreğir - ADANA
T. +90 (322) 346 74 21
F. +90 (322) 346 74 20

www.egeplast.com.tr
export@egeplast.com.tr

www.egeyildiz.com.tr
satis@egeyildiz.com.tr



ECE YILDIZ
"plastik boruda kalite"